

13

Continuous-Time Modulation

In this lecture, we begin the discussion of modulation. This is an important concept in communication systems and, as we will see in Lecture 15, also provides the basis for converting between continuous-time and discrete-time signals. In its most general sense, modulation means using one signal to vary a parameter of another signal. In communication systems, for example, if a channel is particularly suited to transmission in a certain frequency range, the information to be transmitted may be embedded in a carrier signal matched to the channel. The mechanism by which the information is embedded is modulation; that is, the information to be transmitted is used to modulate some parameter of the carrier signal. In sinusoidal frequency modulation, for example, the information is used to modulate the carrier frequency. In sinusoidal amplitude modulation, the carrier is sinusoidal at a frequency that the channel can accommodate, and the information to be transmitted modulates the amplitude of this carrier. Furthermore, in communication systems, if many different signals are to be transmitted over the same channel, a technique referred to as *frequency division multiplexing* is often used. In this method each signal is used to modulate a carrier of a different frequency so that in the composite signal the information for each of the separate signals occupies non-overlapping frequency bands.

The modulation property for Fourier transforms applies directly to amplitude modulation, that is, the interpretation in the frequency domain of the result of multiplying a carrier signal by a modulating signal. From the modulation property we know that for amplitude modulation the spectrum of the modulated output is the convolution of the spectra of the carrier and the modulating signal. When the carrier is either a complex exponential or a sinusoidal signal, the spectrum of the carrier is one or a pair of impulses and the result of the convolution is then to shift the spectrum of the modulating signal to a center frequency equal to the carrier frequency. Modulation with a single complex exponential and with a sinusoidal signal are closely related.

With a complex exponential carrier, demodulation, i.e., recovery of the original modulating signal, is relatively straightforward, basically involving modulating a second time with the complex conjugate signal. With sinusoidal

amplitude modulation, demodulation consists of modulating again with a sinusoidal carrier followed by lowpass filtering to extract the original signal. This form of demodulation is typically referred to as synchronous demodulation since it requires synchronization between the sinusoidal carrier signals in the modulator and demodulator. However, by adding a constant to the modulating signal or equivalently injecting some carrier signal into the modulated output, a simpler form of demodulator can be used. This is referred to as *asynchronous demodulation* and typically results in a less expensive demodulator. However, the fact that a carrier signal is injected into the modulated signal represents an inefficiency of power transmission.

Suggested Reading

Section 7.0, Introduction, pages 447–448

Section 7.1, Continuous-Time Sinusoidal Amplitude Modulation, pages 449–459

Section 7.2, Some Applications of Sinusoidal Amplitude Modulation, pages 459–464

Section 7.3, Single-Sideband Amplitude Modulation, pages 464–468

SINUSOIDAL AMPLITUDE MODULATION

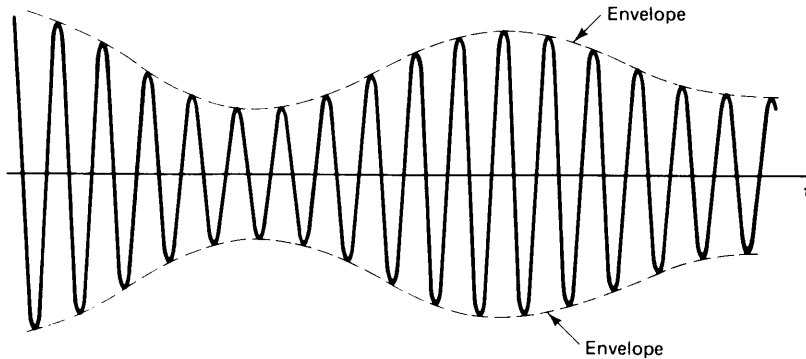

TRANSPARENCY 13.1

Sinusoidal amplitude and frequency modulation with a sinusoidal carrier.

SINUSOIDAL FREQUENCY MODULATION

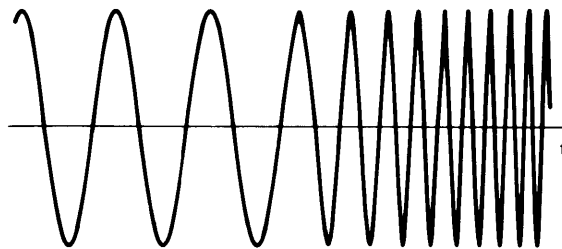

AMPLITUDE MODULATION

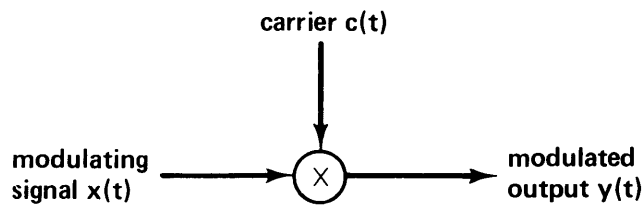

$$x(t) c(t) \xleftrightarrow{\mathcal{F}} \frac{1}{2\pi} [X(\omega) * C(\omega)]$$

- pulse carrier
- sinusoidal carrier

$$c(t) = \cos(\omega_c t + \theta_c)$$
- complex exponential carrier

$$c(t) = e^{j(\omega_c t + \theta_c)}$$

$$= \cos(\omega_c t + \theta_c) + j \sin(\omega_c t + \theta_c)$$

TRANSPARENCY 13.2

Block diagram of amplitude modulation and some examples of commonly used carrier signals.

TRANSPARENCY

13.3

Spectra associated with amplitude modulation with a complex exponential carrier.

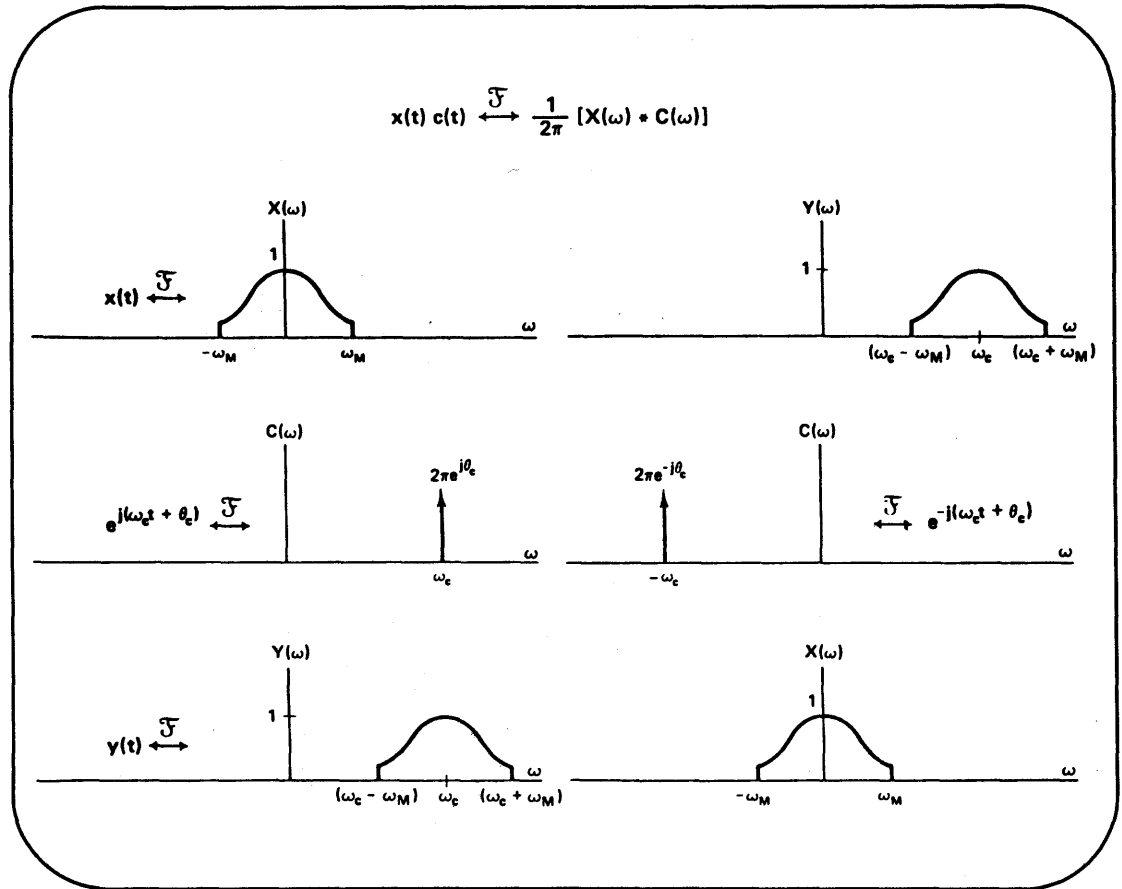

TRANSPARENCY

13.4

Representation of amplitude modulation with a complex exponential carrier in terms of amplitude modulation with two sinusoidal carriers with a 90° phase difference.

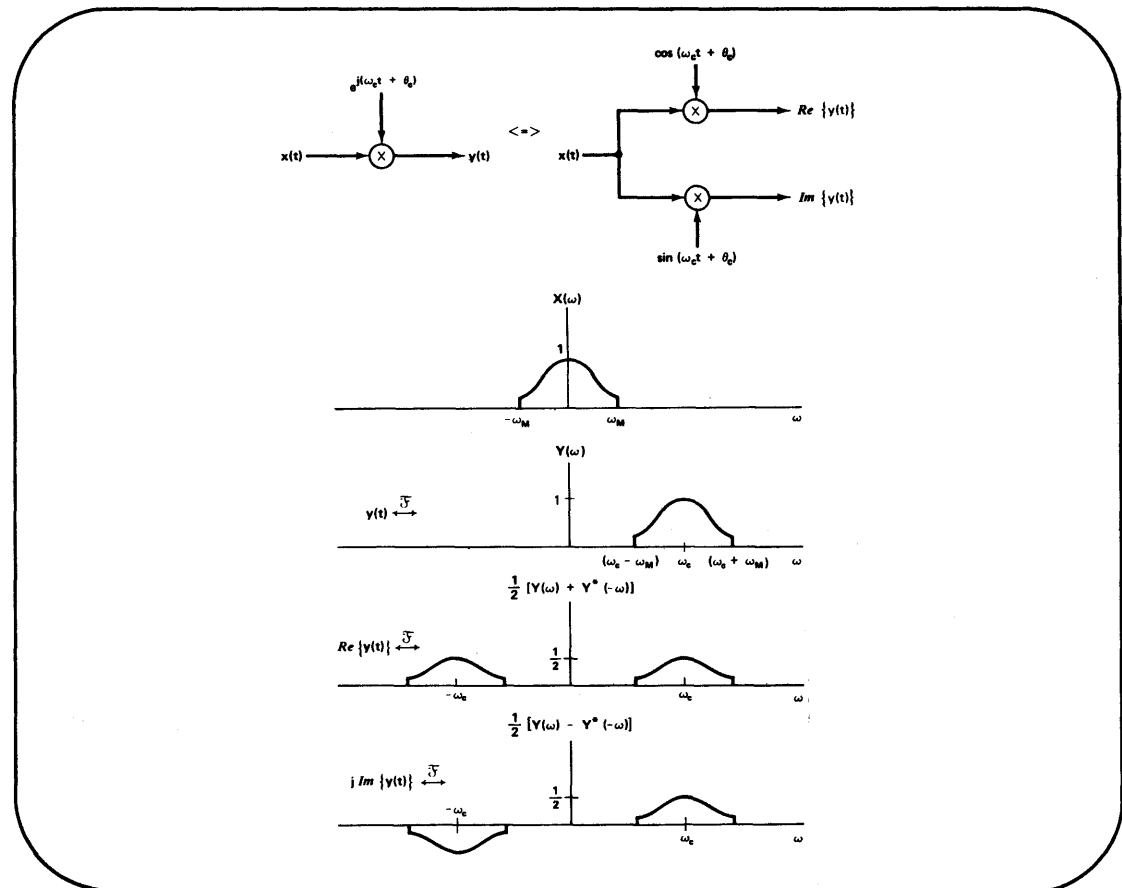

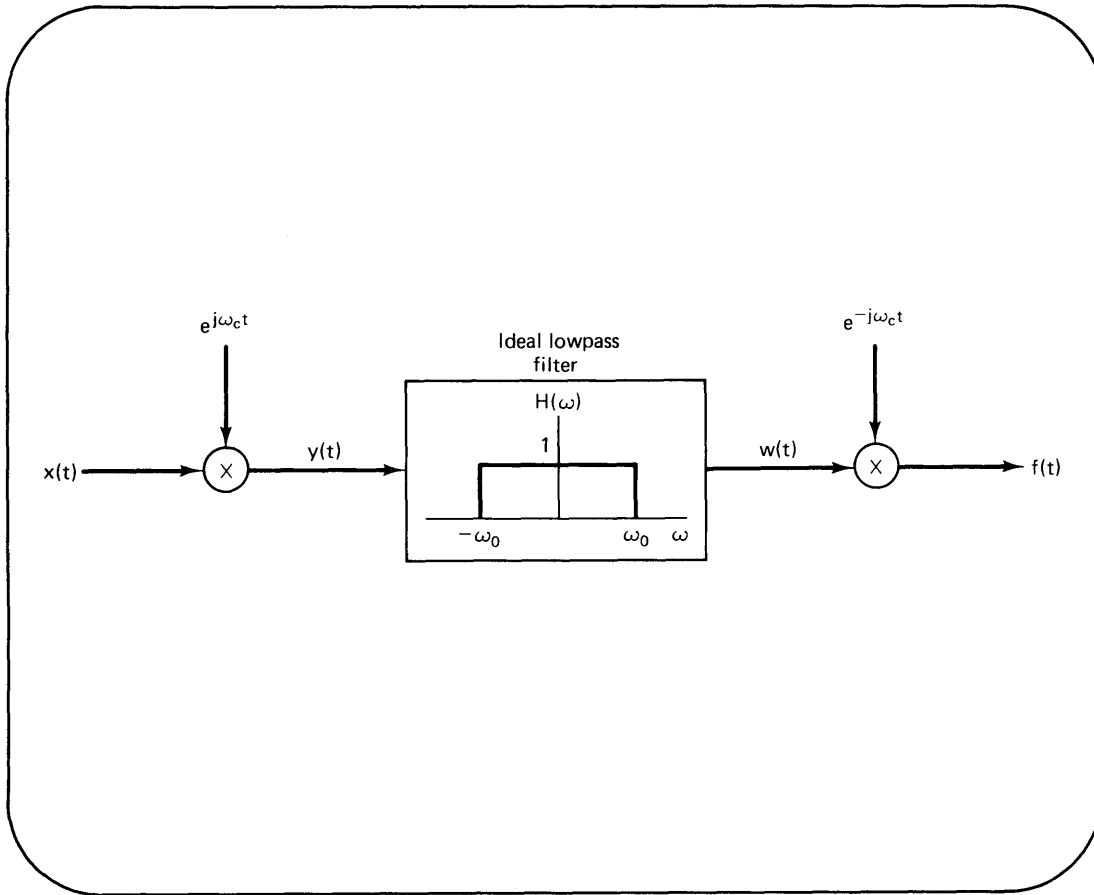

TRANSPARENCY 13.5

The use of amplitude modulation with a complex exponential carrier to implement bandpass filtering with a lowpass filter.

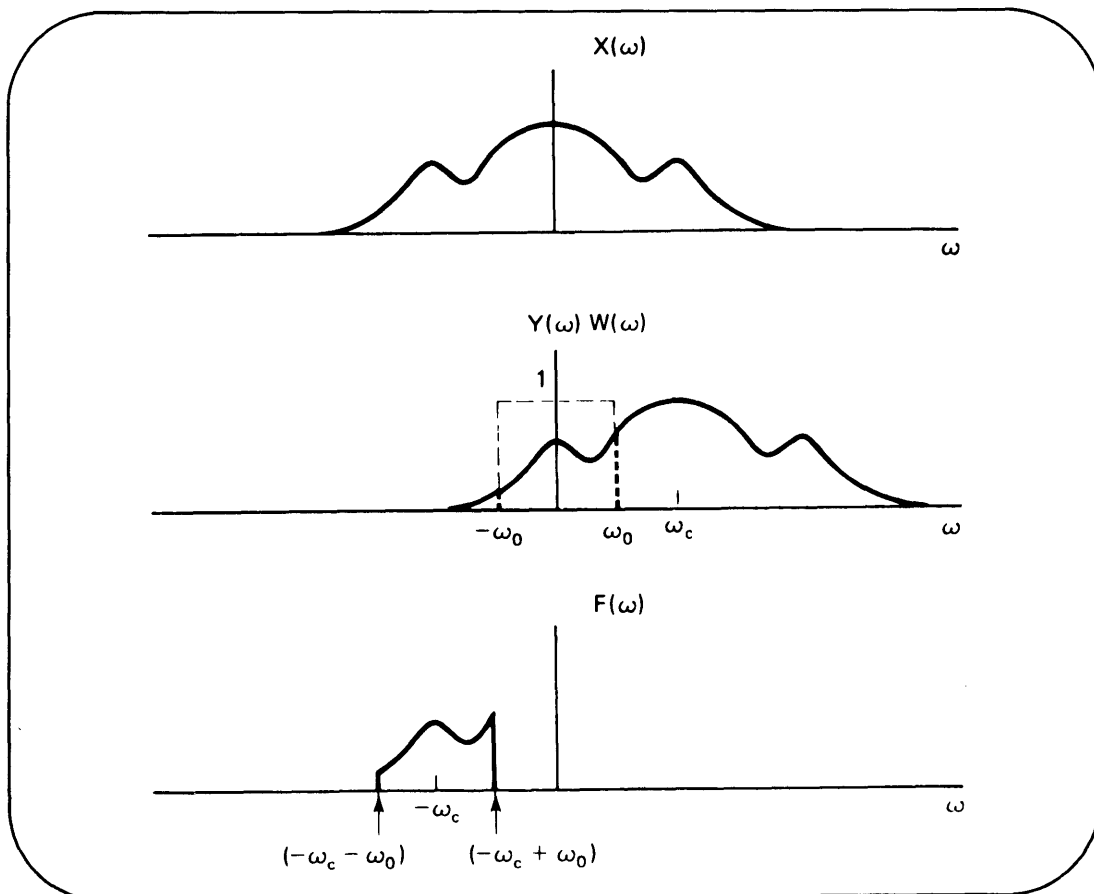

TRANSPARENCY 13.6

Spectra associated with the system in Transparency 13.5.

TRANSPARENCY 13.7

Equivalent frequency response associated with the system in Transparency 13.5.

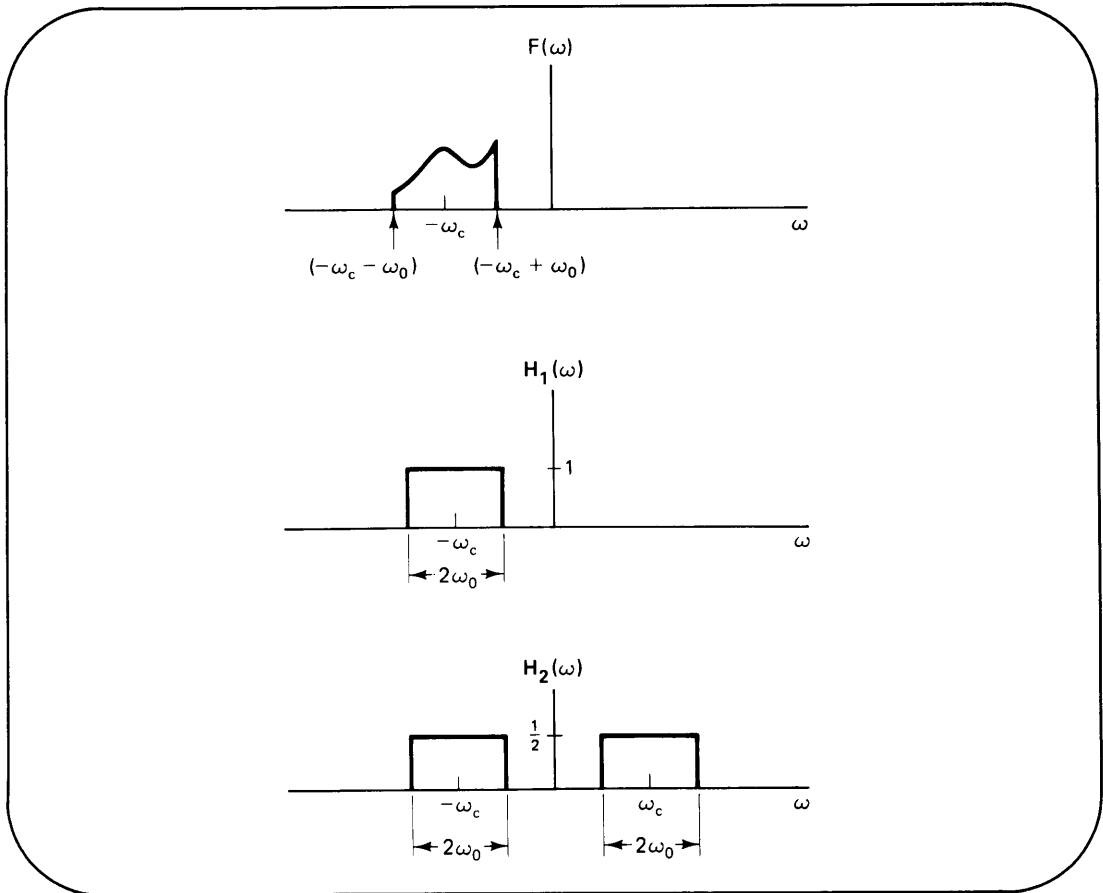

TRANSPARENCY 13.8

Representation of amplitude modulation with a complex exponential carrier in terms of amplitude modulation with two sinusoidal carriers with a 90° phase difference.

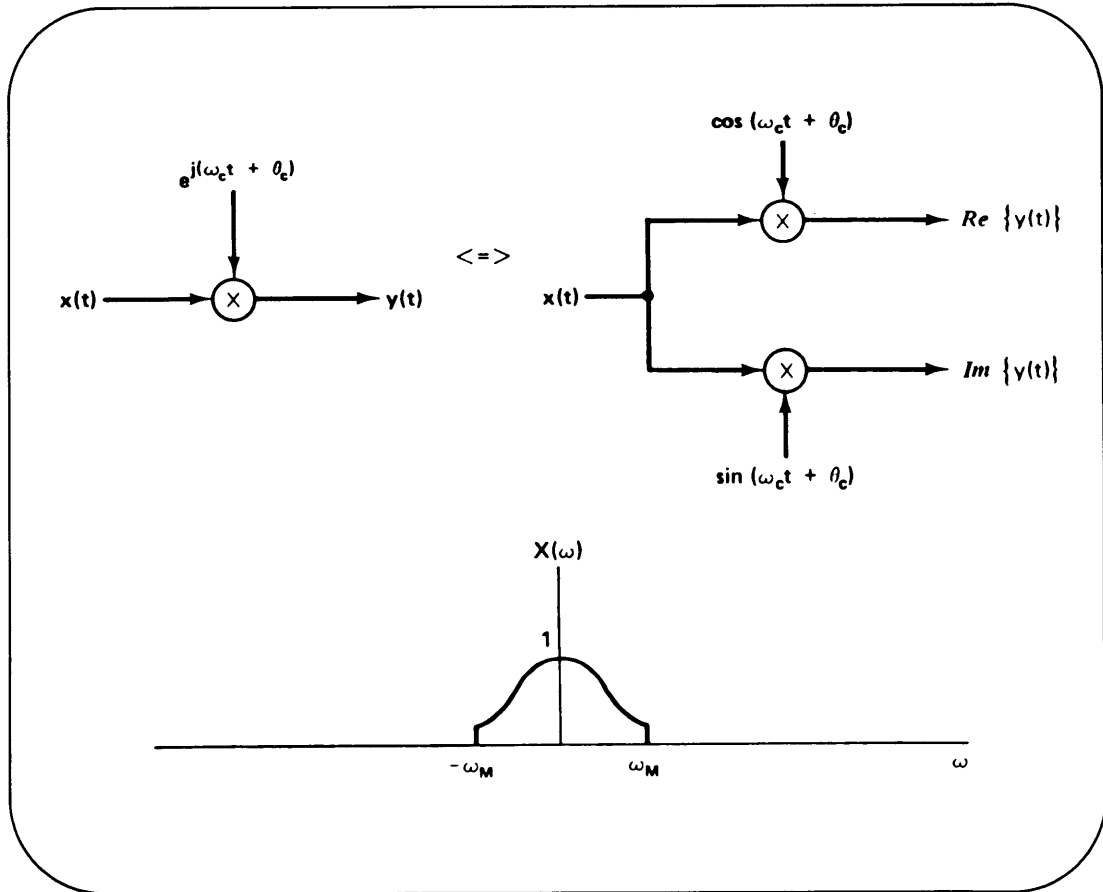

$$c(t) = \cos(\omega_c t + \theta_c)$$

$$= \frac{1}{2} e^{j(\omega_c t + \theta_c)} + \frac{1}{2} e^{-j(\omega_c t + \theta_c)}$$

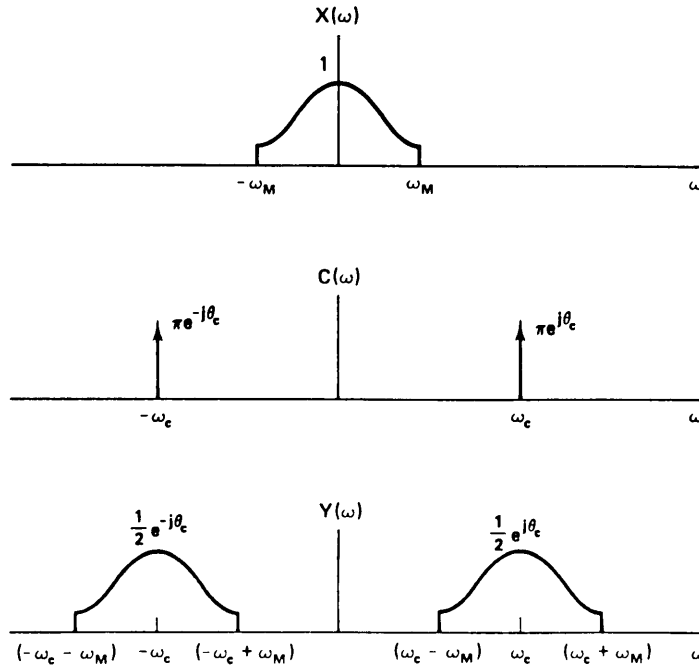

TRANSPARENCY 13.9
Spectra associated with amplitude modulation with a sinusoidal carrier.

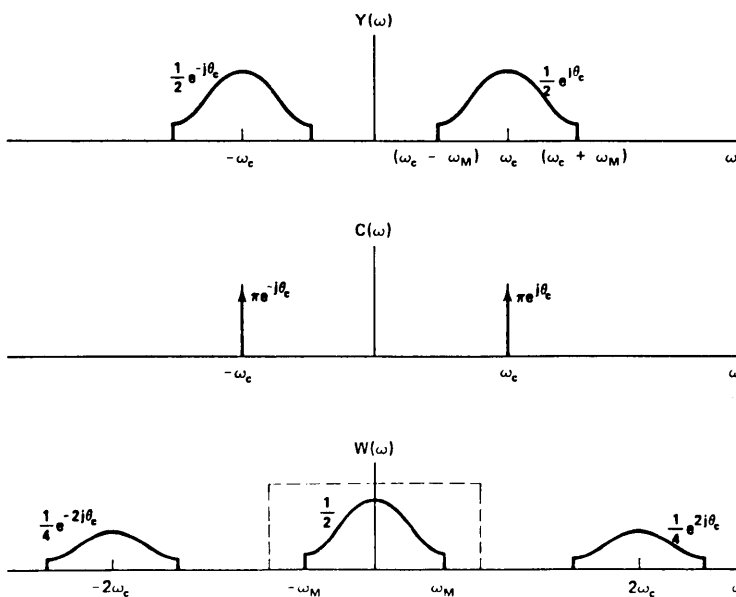
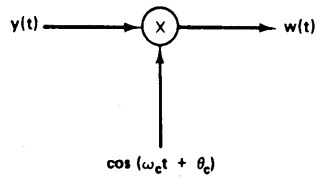

TRANSPARENCY 13.10
Demodulation of an amplitude-modulated signal with a sinusoidal carrier.

TRANSPARENCY 13.11
Block diagram of sinusoidal amplitude modulation and demodulation.

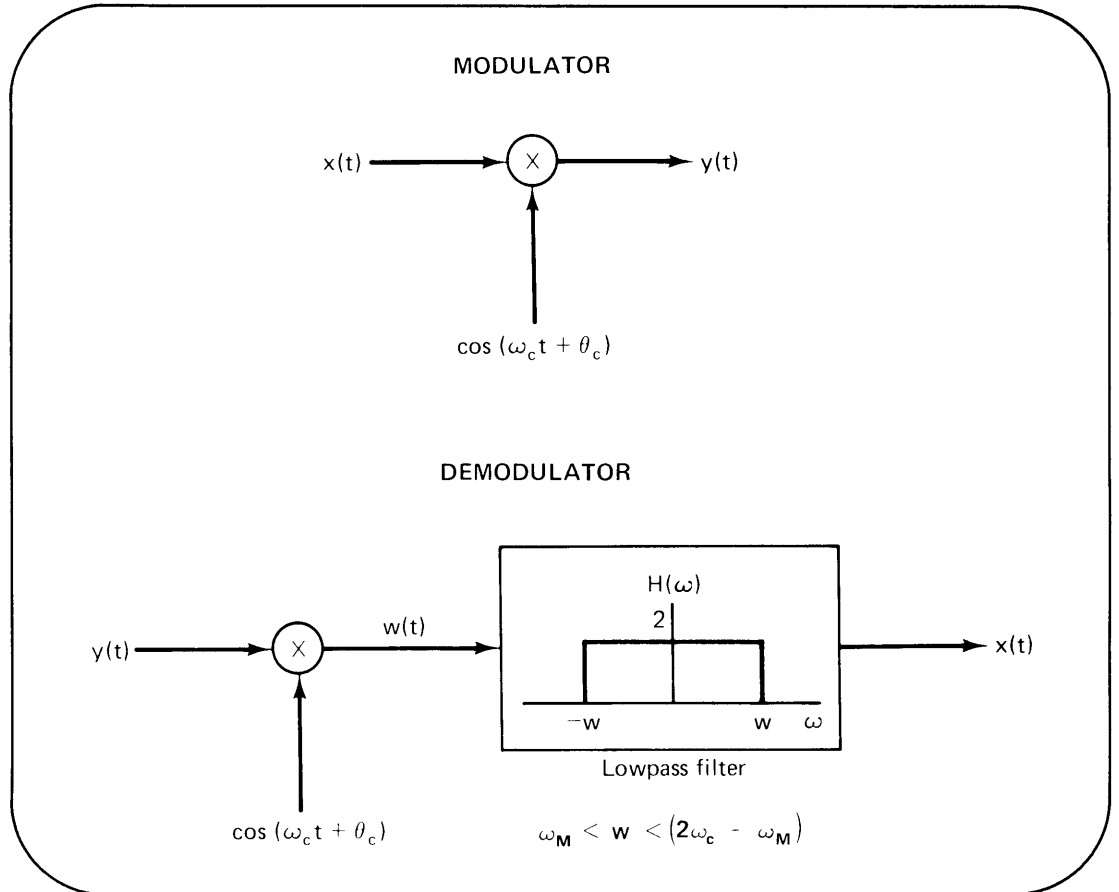

TRANSPARENCY 13.12
Block diagram for frequency division multiplexing.

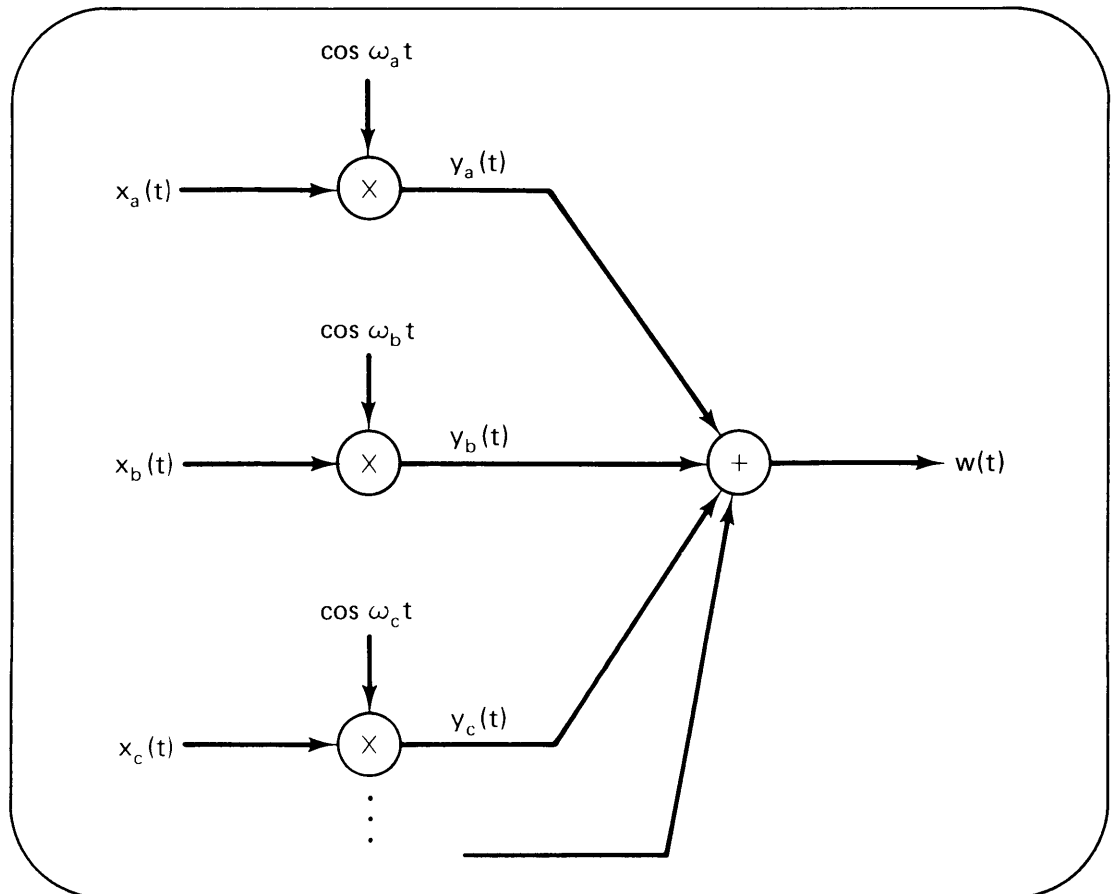

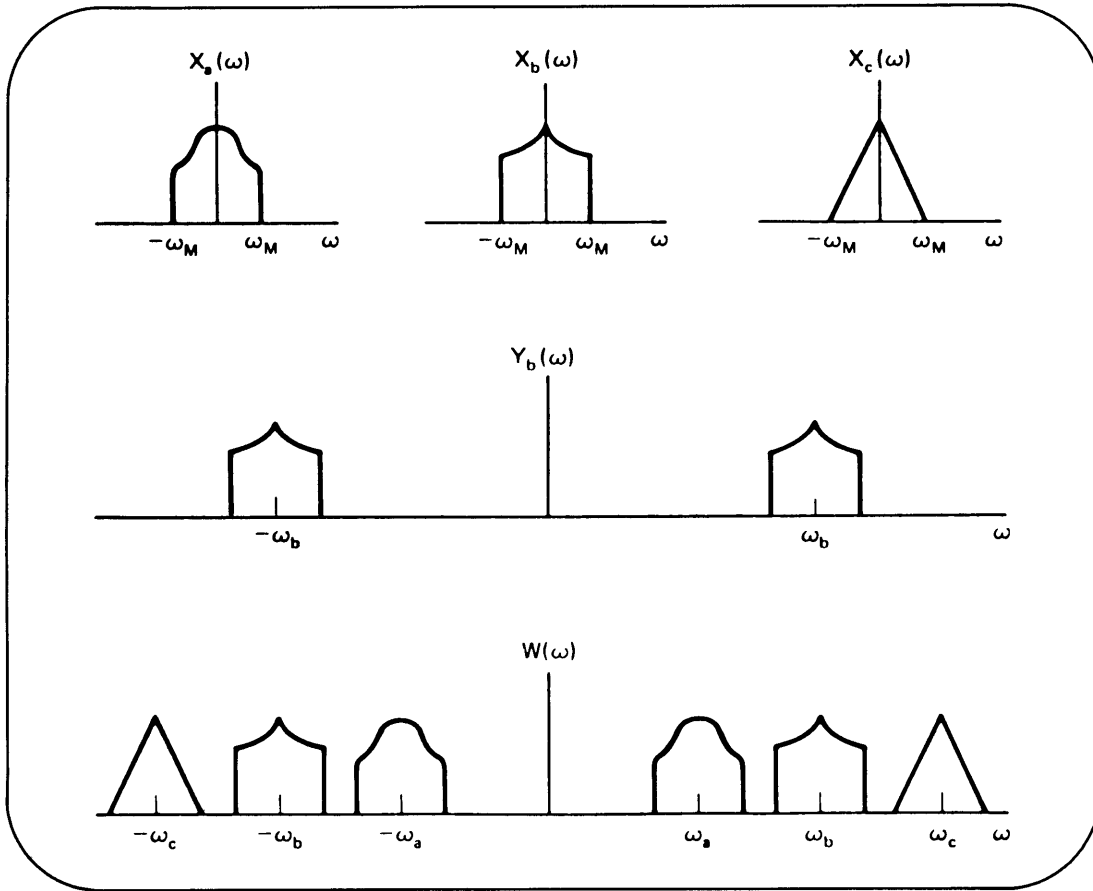

TRANSPARENCY 13.13
Spectra illustrating frequency division multiplexing.

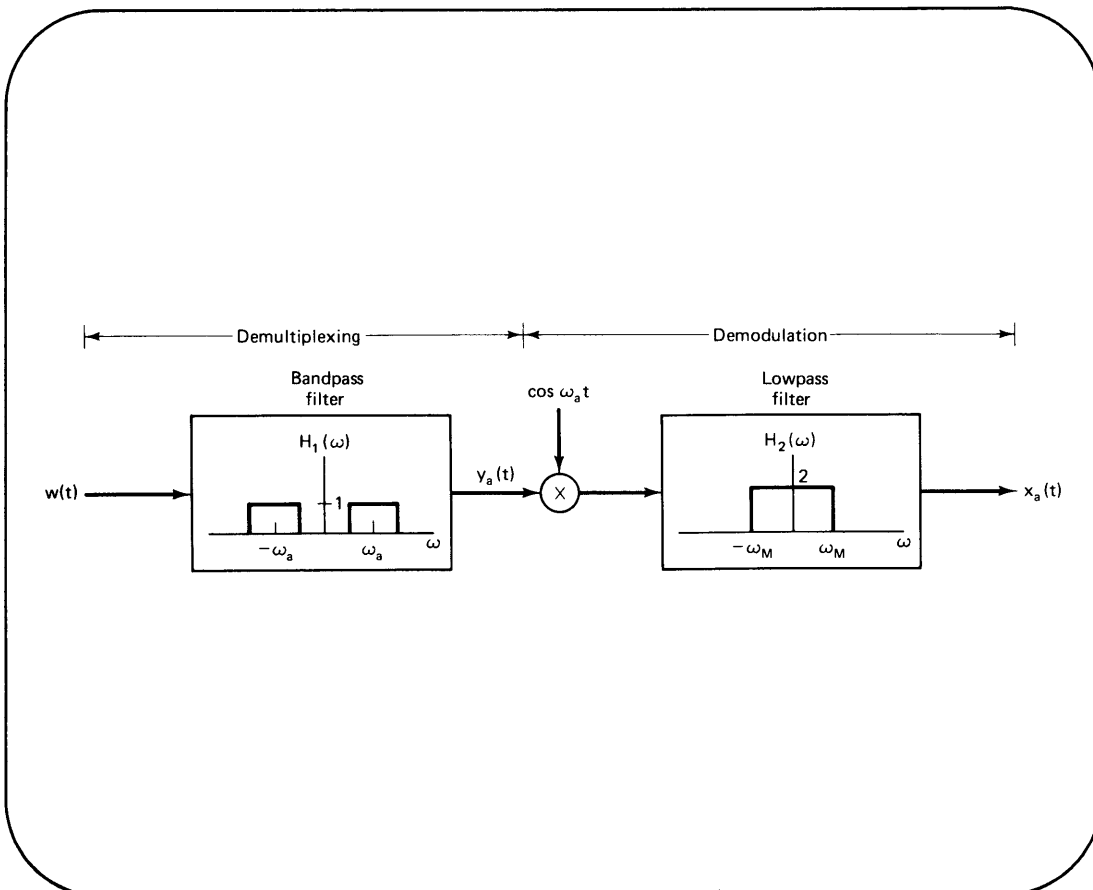

TRANSPARENCY 13.14
Demultiplexing and demodulation of a frequency division multiplexed signal.

TRANSPARENCY

13.15

Demodulation of an amplitude-modulated signal with a sinusoidal carrier.
[Transparency 13.10 repeated]

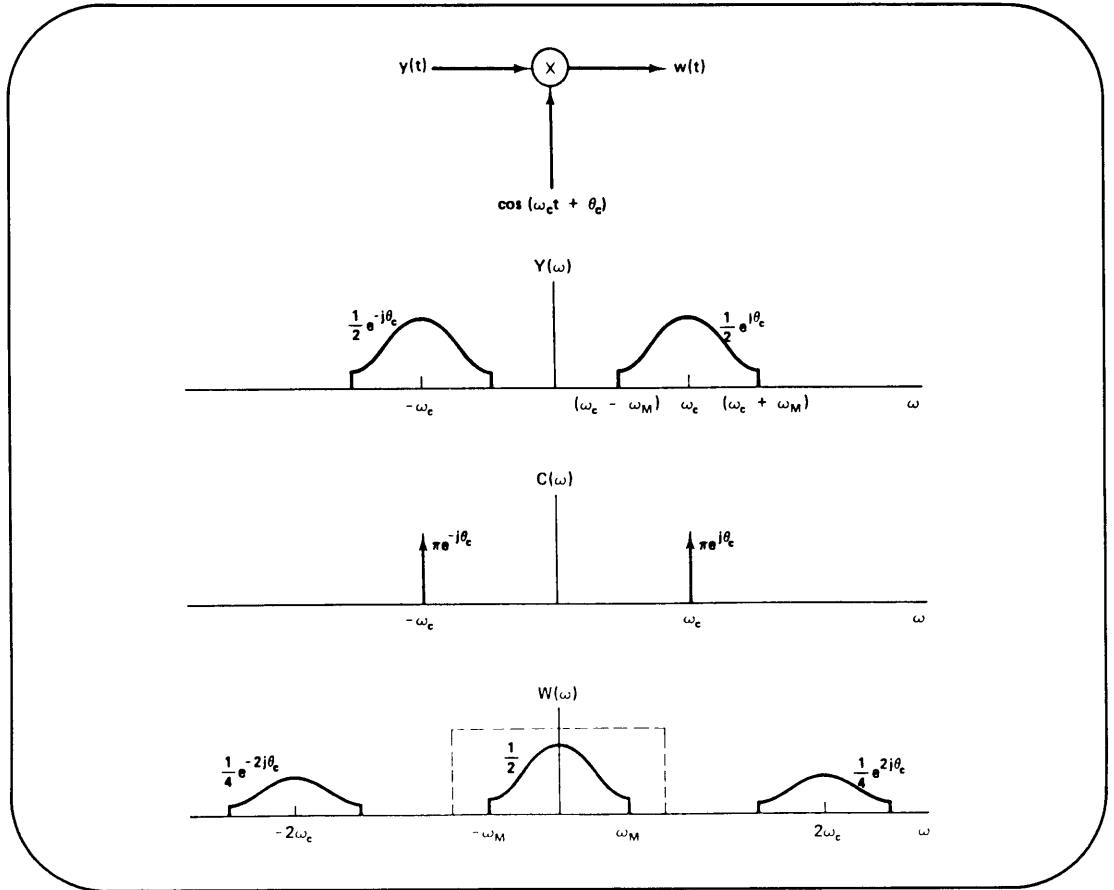

TRANSPARENCY

13.16

Effect of loss of synchronization in phase in a synchronous sinusoidal amplitude modulation/demodulation system.

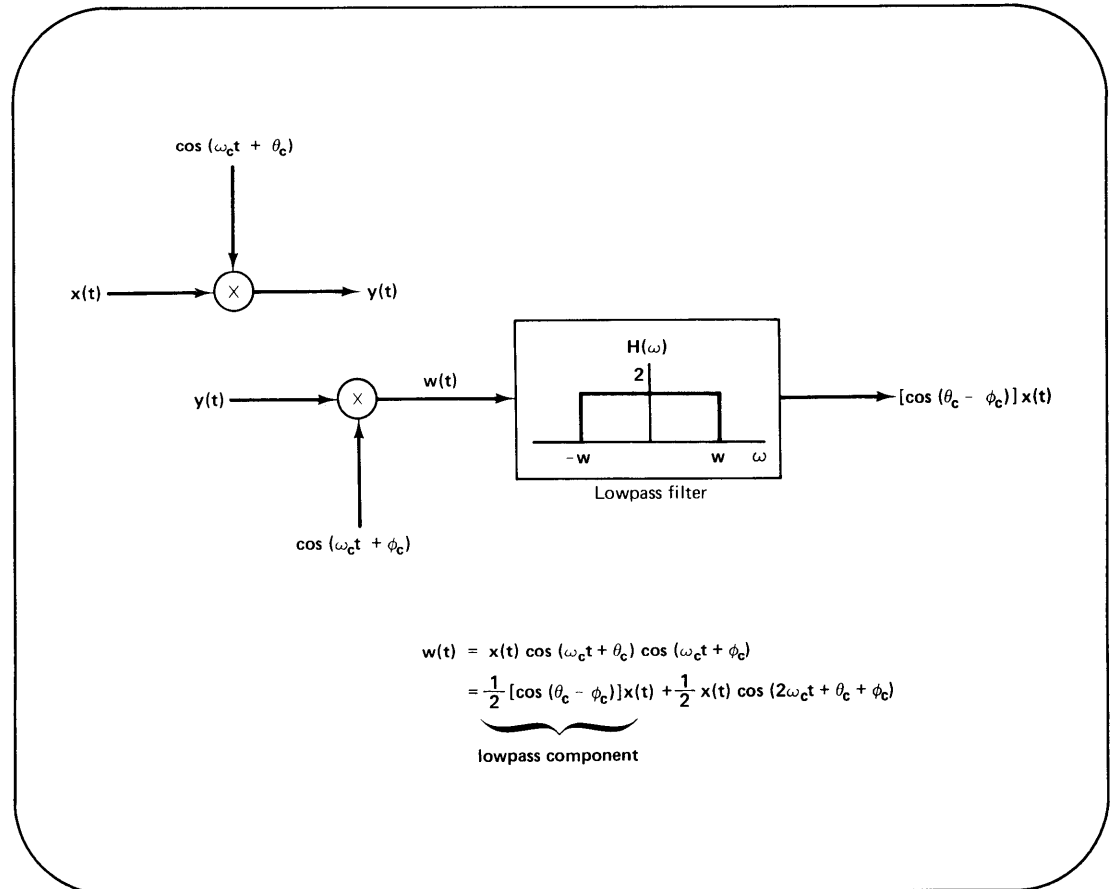

ASYNCHRONOUS DEMODULATION

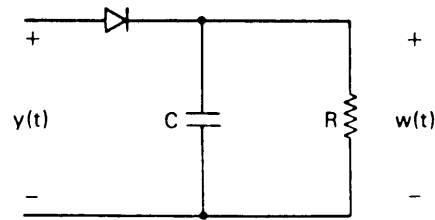
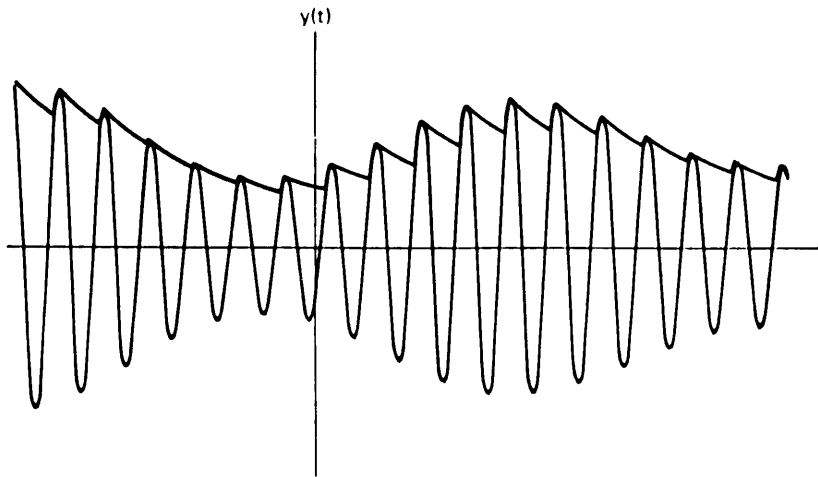

TRANSPARENCY 13.17

A simple system and associated waveform for an asynchronous demodulation system.

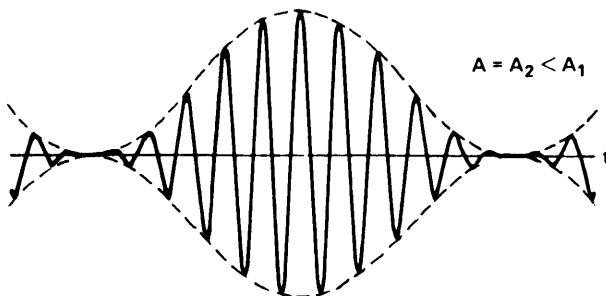
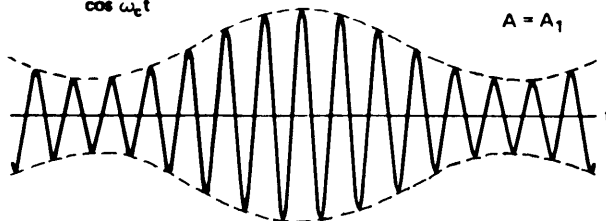
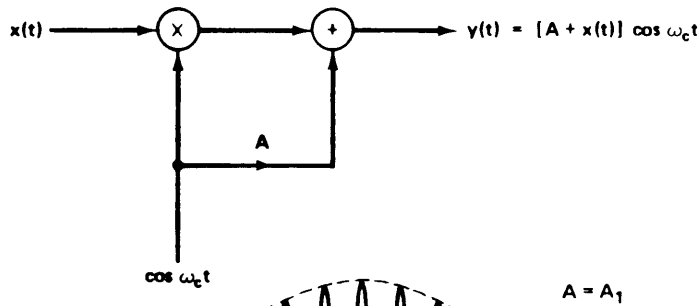

TRANSPARENCY 13.18

Modulator associated with asynchronous sinusoidal amplitude modulation. For such a system the carrier must be injected into the output. This transparency shows time waveforms for the asynchronous modulation system.

TRANSPARENCY 13.19
 Frequency spectra associated with an asynchronous modulation system.

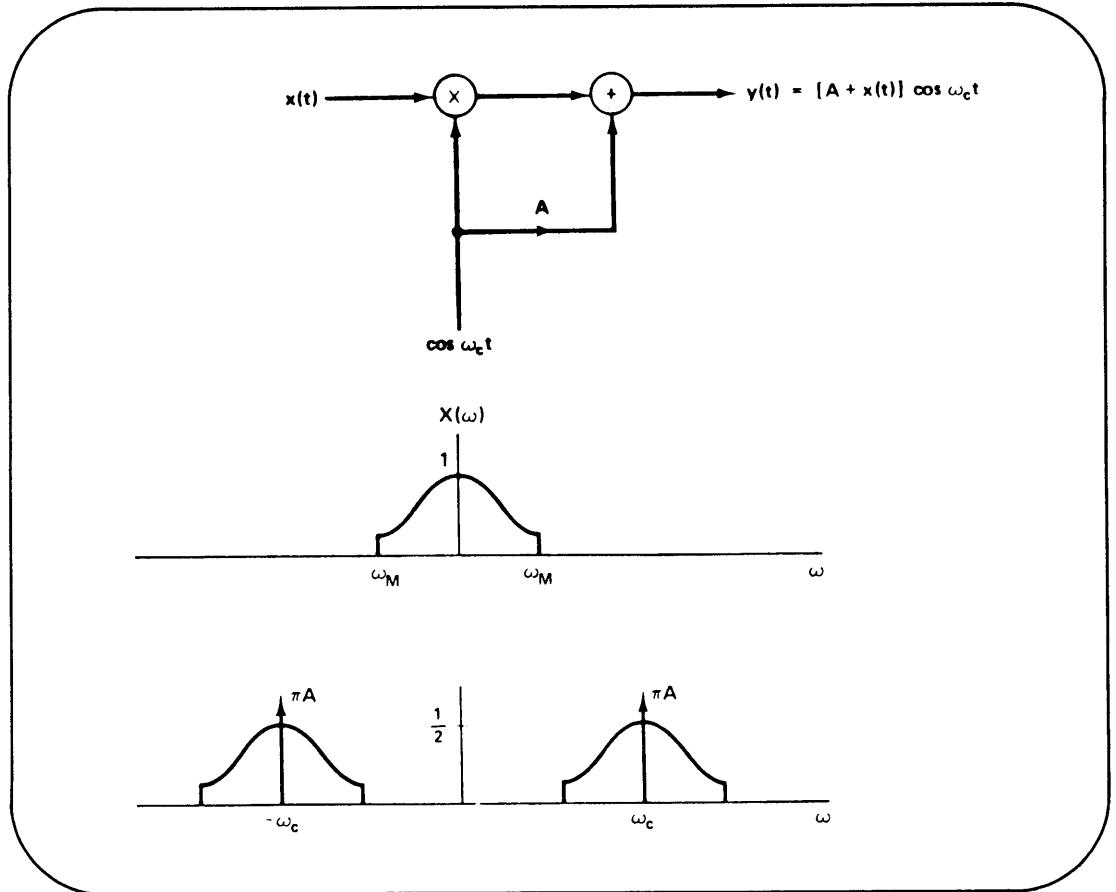

TRANSPARENCY 13.20
 Single-sideband modulation in which only the upper sidebands are retained.

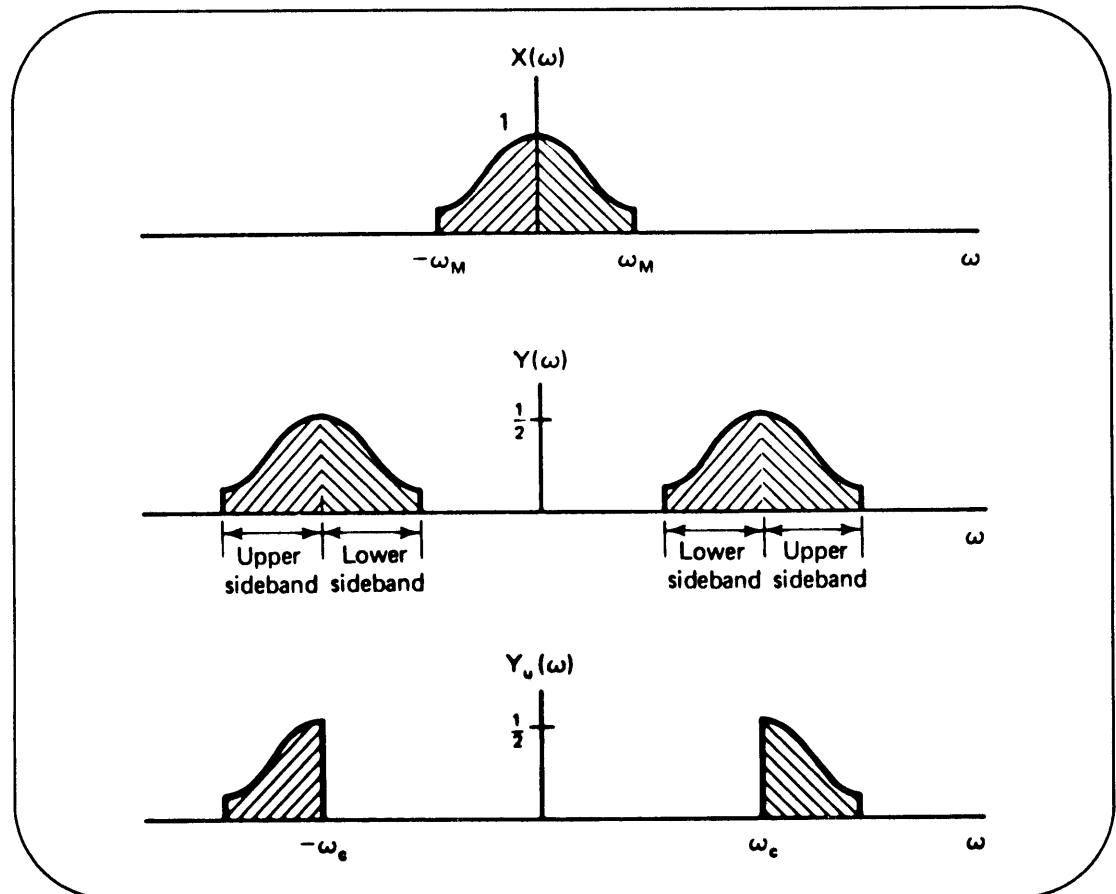

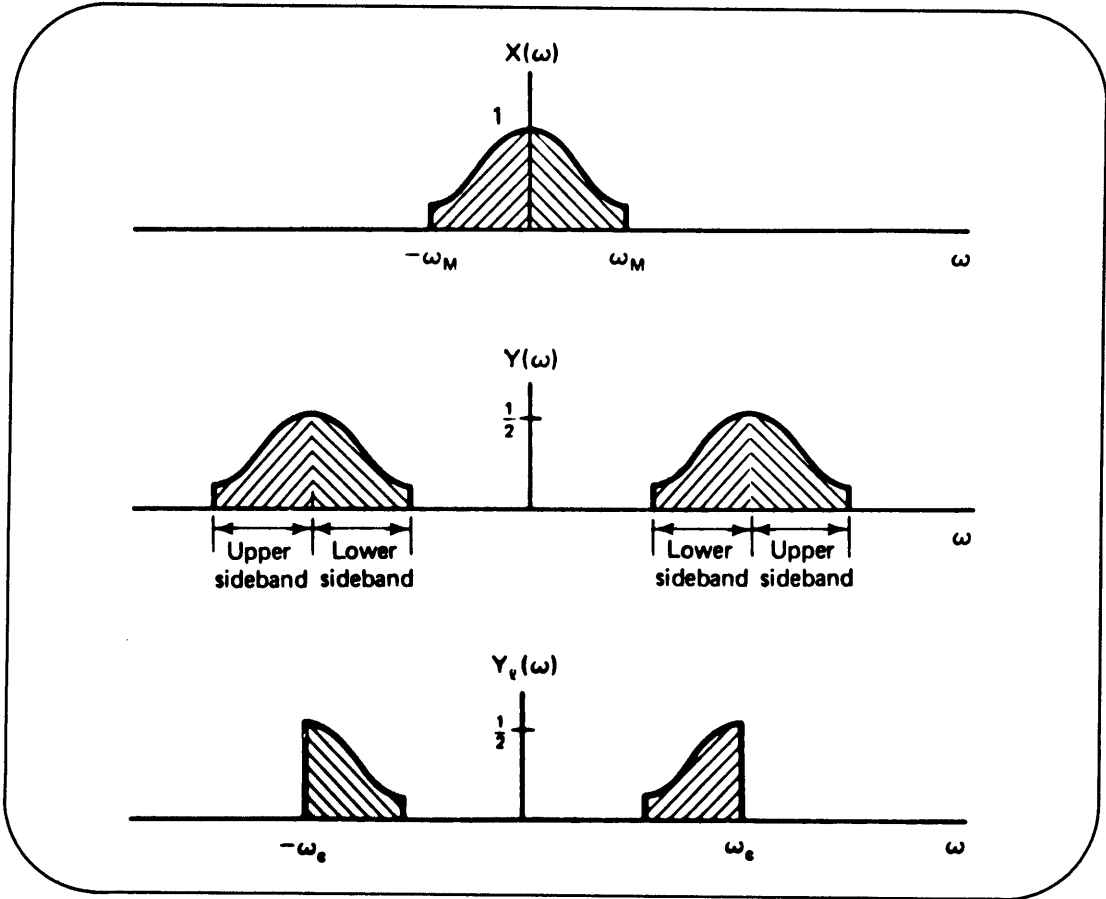

TRANSPARENCY 13.21
Single-sideband modulation in which only the lower sidebands are retained.

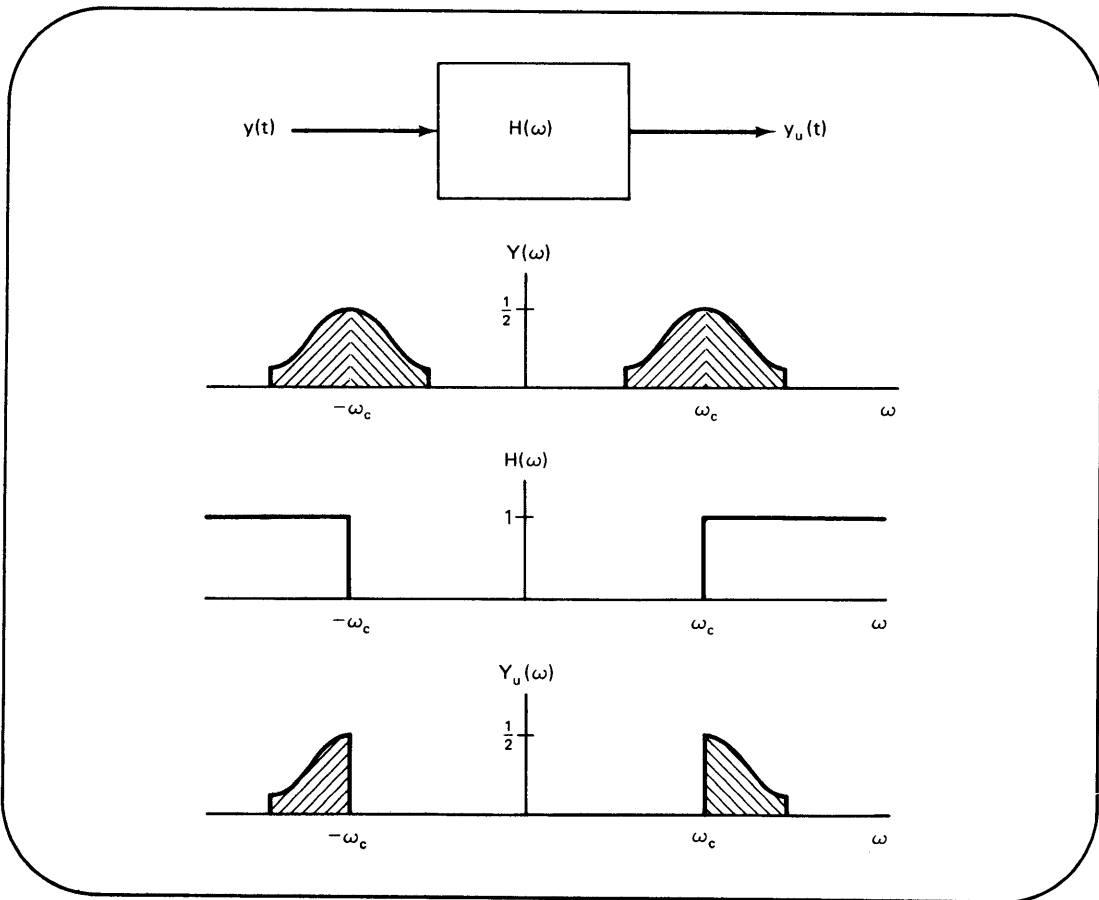

TRANSPARENCY 13.22
The use of a highpass filter to obtain a single-sideband signal.

MIT OpenCourseWare
<http://ocw.mit.edu>

Resource: Signals and Systems
Professor Alan V. Oppenheim

The following may not correspond to a particular course on MIT OpenCourseWare, but has been provided by the author as an individual learning resource.

For information about citing these materials or our Terms of Use, visit: <http://ocw.mit.edu/terms>.