

Agilent Technologies 89410A Getting Started Guide

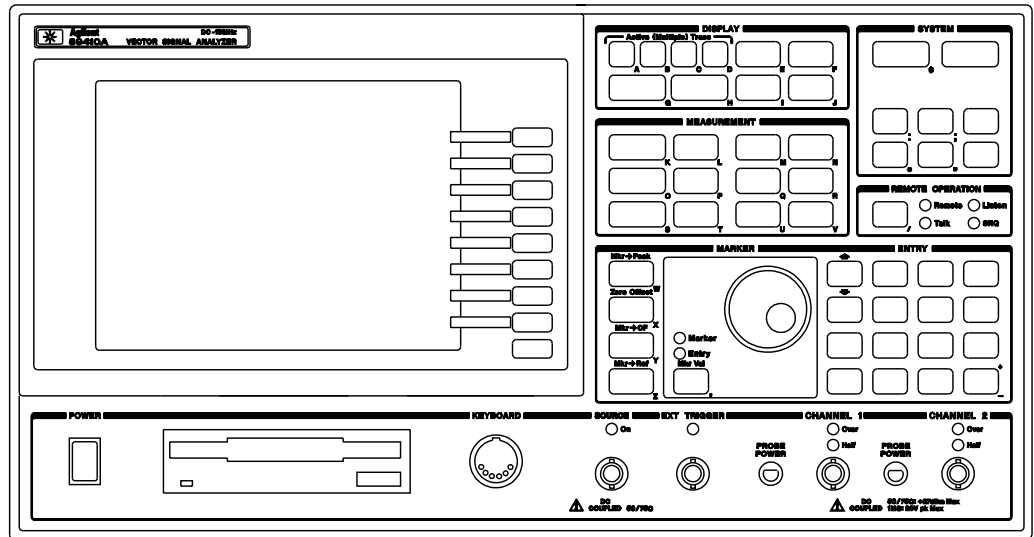

Agilent Technologies Part Number 89410-90092

Printed in U.S.A.

For instruments with firmware version A.08.00

Print Date: May 2000

© Agilent Technologies 1994,1995, 2000. All rights reserved.

8600 Soper Hill Road Everett, Washington 98205-1209 U.S.A.

This software and documentation is based in part on the Fourth Berkeley Software Distribution under license from The Regents of the University of California. We acknowledge the following individuals and institutions for their role in the development: The Regents of the University of California.

The Agilent 89410A at a Glance

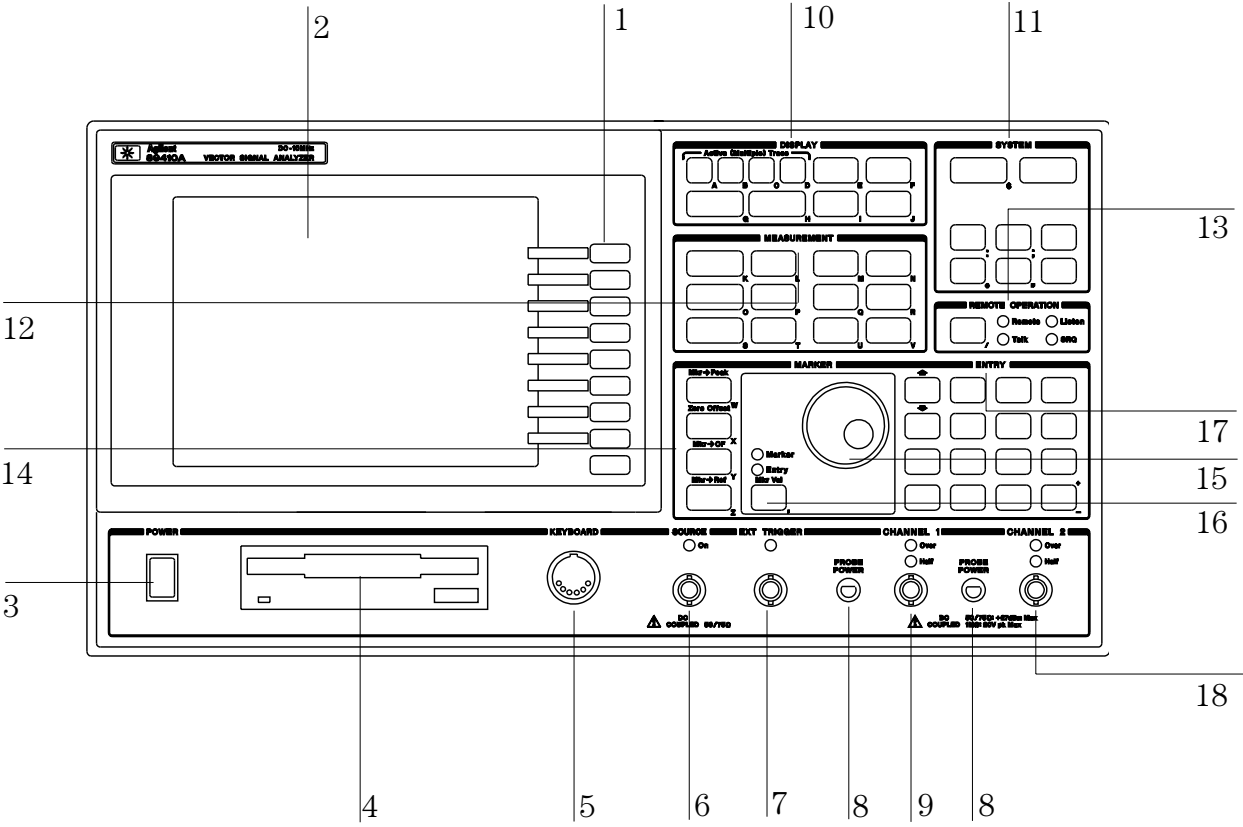

Agilent 89410A Front Panel

- 1**-A softkey's function changes as different menus are displayed. Its current function is determined by the video label to its left, on the analyzer's screen.
- 2**-The analyzer's screen is divided into two main areas. The menu area, a narrow column at the screen's right edge, displays softkey labels. The data area, the remaining portion of the screen, displays traces and other data.
- 3**-The POWER switch turns the analyzer on and off.
- 4**-Use a 3.5 inch flexible disk (DS,HD) in this disk drive to save your work.
- 5**-The KEYBOARD connector allows you to attach an optional keyboard to the analyzer. The keyboard is most useful for writing and editing HP Instrument BASIC programs.
- 6**- The SOURCE connector routes the analyzer's source output to your DUT. Output impedance is selectable: 50 ohms or 75 ohms.
- 7**-The EXT TRIGGER connector lets you provide an external trigger for the analyzer.
- 8**-The PROBE POWER connectors provides power for various HP active probes.
- 9**-The CHANNEL 1 input connector routes your test signal or DUT output to the analyzer's receiver. Input impedance is selectable: 50 ohms, 75 ohms, or 1 megohm.
- 10**-Use the DISPLAY hardkeys and their menus to select and manipulate trace data and to select display options for that data.
- 11**-Use the SYSTEM hardkeys and their menus to control various system functions (online help, plotting, presetting, and so on).
- 12**-Use the MEASUREMENT hardkeys and their menus to control the analyzer's receiver and source, and to specify other measurement parameters.
- 13**-The REMOTE OPERATION hardkey and LED indicators allow you to set up and monitor the activity of remote devices.
- 14**-Use the MARKER hardkeys and their menus to control marker positioning and marker functions.
- 15**-The knob's primary purpose is to move a marker along the trace. But you can also use it to change values during numeric entry, move a cursor during text entry, or select a hypertext link in help topics
- 16**-Use the Marker/Entry key to determine the knob's function. With the Marker indicator illuminated the knob moves a marker along the trace. With the Entry indicator illuminated the knob changes numeric entry values.
- 17**-Use the ENTRY hardkeys to change the value of numeric parameters or to enter numeric characters in text strings.
- 18**-The optional CHANNEL 2 input connector routes your test signal or DUT output to the analyzer's receiver. Input impedance is selectable: 50 ohms, 75 ohms, or 1 megohm. For ease of upgrading, the CHANNEL 2 BNC connector is installed even if option AY7 (second input channel) is not installed.

For more details on the HP 89410A front panel, display the online help topic "Front Panel". See the chapter "Using Online Help" if you are not familiar with using the online help index.

This page left intentionally blank

Safety Summary

The following general safety precautions must be observed during all phases of operation of this instrument. Failure to comply with these precautions or with specific warnings elsewhere in this manual violates safety standards of design, manufacture, and intended use of the instrument. Agilent Technologies, Inc. assumes no liability for the customer's failure to comply with these requirements.

GENERAL

This product is a Safety Class 1 instrument (provided with a protective earth terminal). The protective features of this product may be impaired if it is used in a manner not specified in the operation instructions.

All Light Emitting Diodes (LEDs) used in this product are Class 1 LEDs as per IEC 60825-1.

ENVIRONMENTAL CONDITIONS

This instrument is intended for indoor use in an installation category II, pollution degree 2 environment. It is designed to operate at a maximum relative humidity of 95% and at altitudes of up to 2000 meters. Refer to the specifications tables for the ac mains voltage requirements and ambient operating temperature range.

BEFORE APPLYING POWER

Verify that the product is set to match the available line voltage, the correct fuse is installed, and all safety precautions are taken. Note the instrument's external markings described under Safety Symbols.

GROUND THE INSTRUMENT

To minimize shock hazard, the instrument chassis and cover must be connected to an electrical protective earth ground. The instrument must be connected to the ac power mains through a grounded power cable, with the ground wire firmly connected to an electrical ground (safety ground) at the power outlet. Any interruption of the protective (grounding) conductor or disconnection of the protective earth terminal will cause a potential shock hazard that could result in personal injury.

FUSES

Only fuses with the required rated current, voltage, and specified type (normal blow, time delay, etc.) should be used. Do not use repaired fuses or short-circuited fuse holders. To do so could cause a shock or fire hazard.

DO NOT OPERATE IN AN EXPLOSIVE ATMOSPHERE

Do not operate the instrument in the presence of flammable gases or fumes.

DO NOT REMOVE THE INSTRUMENT COVER

Operating personnel must not remove instrument covers. Component replacement and internal adjustments must be made only by qualified service personnel.

Instruments that appear damaged or defective should be made inoperative and secured against unintended operation until they can be repaired by qualified service personnel.

WARNING

The WARNING sign denotes a hazard. It calls attention to a procedure, practice, or the like, which, if not correctly performed or adhered to, could result in personal injury. Do not proceed beyond a WARNING sign until the indicated conditions are fully understood and met.

Caution

The CAUTION sign denotes a hazard. It calls attention to an operating procedure, or the like, which, if not correctly performed or adhered to, could result in damage to or destruction of part or all of the product. Do not proceed beyond a CAUTION sign until the indicated conditions are fully understood and met.

Safety Symbols



Warning, risk of electric shock



Caution, refer to accompanying documents



Alternating current



Both direct and alternating current



Earth (ground) terminal



Protective earth (ground) terminal



Frame or chassis terminal



Terminal is at earth potential.



Standby (supply). Units with this symbol are not completely disconnected from ac mains when this switch is off

Notation Conventions

Before you use this book, it is important to understand the types of keys on the front panel of the analyzer and how they are denoted in this book.

Hardkeys Hardkeys are front-panel buttons whose functions are always the same. Hardkeys have a label printed directly on the key. In this book, they are printed like this: **[Hardkey]**.

Softkeys Softkeys are keys whose functions change with the analyzer's current menu selection. A softkey's function is indicated by a video label to the left of the key (at the edge of the analyzer's screen). In this book, softkeys are printed like this: [softkey].

Toggle Softkeys Some softkeys toggle through multiple settings for a parameter. Toggle softkeys have a word highlighted (of a different color) in their label. Repeated presses of a toggle softkey changes which word is highlighted with each press of the softkey. In this book, toggle softkey presses are shown with the requested toggle state in bold type as follows:

"Press [key name **on**]" means "press the softkey [key name] until the selection **on** is active."

Shift Functions In addition to their normal labels, keys with blue lettering also have a shift function. This is similar to shift keys on a pocket calculator or the shift function on a typewriter or computer keyboard. Using a shift function is a two-step process. First, press the blue **[Shift]** key (at this point, the message "shift" appears on the display). Then press the key with the shift function you want to enable. Shift function are printed as two key presses, like this:

[Shift] [Shift Function]

Numeric Entries Numeric values may be entered by using the numeric keys in the lower right hand ENTRY area of the analyzer front panel. In this book values which are to be entered from these keys are indicated only as numerals in the text, like this:
Press 50, [enter]

Ghosted Softkeys A softkey label may be shown in the menu when it is inactive. This occurs when a softkey function is not appropriate for a particular measurement or not available with the current analyzer configuration. To show that a softkey function is not available, the analyzer "ghosts" the inactive softkey label. A ghosted softkey appears less bright than a normal softkey. Settings/values may be changed while they are inactive. If this occurs, the new settings are effective when the configuration changes such that the softkey function becomes active.

In This Book

This book, “Agilent 89410A Getting Started Guide”, is designed to help you become comfortable with the Agilent 89410A DC-10MHz Vector Signal Analyzer. It provides step-by step examples of how to use this analyzer to perform tasks which you have probably performed with other analyzers. By performing these tasks you will become familiar with many of the basic features—and how those features fit together to perform actual measurements.

This book also contains a chapter to help you prepare the analyzer for use, including instructions for inspecting and installing the Agilent 89410A.

To Learn More About the Agilent 89410A

You may need to use other books in the Agilent 89410A manual set. See the “Documentation Roadmap” at the end of this book to learn what each book contains.

This page left intentionally blank

Table of Contents

1 Using Online Help

- To learn about online help 1-2
- To display help for hardkeys and softkeys 1-3
- To display a related help topic 1-4
- To select a topic from the help index 1-5

2 Making Simple Noise Measurements

- To measure random noise 2-2
- To measure band power 2-3
- To measure signal to noise ratios 2-4
- To measure adjacent-channel power 2-6

3 Using Gating to Characterize a Burst Signal

- To Use Time Gating 3-2

4 Measuring Relative Phase

- To measure the relative phase of an AM signal 4-2
- To measure the relative phase of an PM signal 4-4

5 Characterizing a Filter

- To set up a frequency response measurement 5-2
- To use the absolute marker 5-4
- To use the relative marker 5-5
- To use the search marker 5-6
- To display phase 5-7
- To display coherence 5-8

6 General Tasks

- To set up peripherals. 6-2
- To print or plot screen contents 6-3
- To save data with an internal or RAM disk 6-4
- To recall data with an internal or RAM disk 6-5
- To format a disk 6-6
- To create a math function 6-7
- To use a math function 6-8
- To display a summary of instrument parameters 6-9

Inspection and Installation

7 Preparing the Analyzer for Use

- Preparing the Analyzer for Use 7-2
- To do the incoming inspection 7-5
- To install the analyzer 7-7
- To change the line-voltage selector switch 7-8
- To change the fuse 7-9
- To connect the analyzer to a LAN 7-10
- To connect the analyzer to a serial device 7-10
- To connect the analyzer to a parallel device 7-11
- To connect the analyzer to an HP-IB device 7-11
- To connect the analyzer to an external monitor 7-12
- To connect an external frequency reference 7-12
- To connect the optional frequency reference 7-13
- To connect the optional keyboard 7-14
- To clean the screen 7-16
- To store the analyzer 7-16
- To transport the analyzer 7-17
- If the analyzer will not power up 7-18

Index

Documentation Road Map

Need Assistance

1

Using Online Help

You can learn about your analyzer from online help which is built right into the instrument and is available to you any time you use the analyzer. This section shows you how to use online help to learn about specific keys or topics. You can use online help in conjunction with other documentation to learn about your analyzer in depth, or you can refresh your memory for keys you seldom use. You can use online help while working with your analyzer since online help does not alter the analyzer setup.

To learn about online help

- 1** Enter the online help system:
Press **[Help]**.
- 2** Display online help for the **[Help]** hardkey:
Press **[5]** on the numeric keypad.
- 3** Use the knob or the up-arrow or down-arrow keys to move through the pages.
- 4** Quit online help:
Press **[Help]**.
or
Press **[0]** on the keypad.

Take a few moments to read the help overview. It's only five pages long, and it includes descriptions of advanced features like the index and cross-reference "links" that can help you locate the information you need more quickly.

When you enter the help system it displays help on the last key you pressed. If you have just turned on the analyzer online help for the **[Help]** key is displayed.

When you quit help, the analyzer restores the display and menu that was displayed before you enabled help. Using online help does not alter your measurement setup.

```

Topic: [Help] Hardkey
-----
How to use online Help

If you want to:                then do this:
-----
EXIT help                       Press [Help] or [0]
Display help for a key          Press that key
Display the index               Press [1]

Page through a topic            Press an arrow key
Scroll through a topic          Turn the knob
Select a link                    Turn the knob

Jump to the selected link       Press [4]
Return to a previous topic      Press [7]
Print a topic                    Press [8]

Scroll down (turn the knob) for more help.

-----
Prev Topic-7      Print-8      Prev Page-^      Index-1
Jump To Topic-4   Help On Help-5  Next Page-v      Quit-0

```

This legend shows which numeric keys access online help features

To display help for hardkeys and softkeys

This example displays topics related to triggering.

- 1** Enter the online help system:
Press [**Help**].
- 2** Display help for a hardkey:
Press [**Trigger**].
- 3** Use the knob or the up and down arrow keys to page through the topic.
- 4** Select a softkey topic:
Press [trigger type], [IF channel 1].
- 5** Quit online help:
Press [**Help**]
or
Press [**0**] on the keypad.

Pressing [**Preset**] always returns the analyzer to its preset state. If you press any other key when help is enabled, the analyzer displays a help topic describing the key's function. For help on the preset state, select "Preset hardkey" from the help index (you will learn how to do this later in this section) or press [**Preset**] then [**Help**].

These lines show the name of the selected softkey and the path to its hardkey

```

Topic: [IF channel X] Softkey (trigger)
Key Path: [Trigger] -> [trigger type]
Uses the specified channel's IF signal as the trigger
signal.

NOTE This softkey is ghosted (inactive) if
the instrument mode is Scalar or if the
measurement is baseband. IF trigger is
available only when the measurement is
zoomed and only when the instrument mode
is Vector or Demodulation.

When you select IF trigger, the analyzer begins a
measurement when the IF signal meets the
trigger conditions you've specified. This lets you,
for instance, trigger the analyzer when your signal
falls within the current span.

The trigger conditions you can specify are
trigger level, trigger slope, and
trigger delay. A measurement begins when the input

Prev Topic-7      Print-8      Prev Page-^      Index-1
Jump To Topic-4  Help On Help-5  Next Page-v      Quit-0

```

To display a related help topic

This example displays topics related to saving and recalling.

- 1** Enter the online help system:
Press [**Help**].
- 2** Display help for a hardkey:
Press [**Save/Recall**].
- 3** Scroll with the knob to highlight the Math topic.
- 4** Select that topic:
Press [**4**].
- 5** Return to previous topics:
Press [**7**].
- 6** Quit online help:
Press [**Help**].

On a given screen full of online help text, there may be several special words (or phrases) that are linked to related topics. Most of these words are underlined to identify them as links, but one is highlighted to identify it as the currently-selected link. The knob allows you to select a different link by moving the highlighting from one link to the next. Once you've selected the link you want, press [**4**] on the keypad to display the related topic.

You can follow links through as many as 20 topics and still return to the original topic. Just press [**7**] one time for each link you followed, and you'll return to the original topic via all of the related topics you displayed.

The highlighted link shows what topic is displayed if you press 4

Underlined links show other topics available from this online help topic

```

Topic: [Save/Recall] Hardkey

Displays a softkey menu that lets you load traces
into the analyzer's data registers and save and
recall the following types of files to and from disk:

* Individual trace.
* Instrument state.
* Math definition.
* HP Instrument BASIC program.
* Time capture buffer contents.

NOTE When you save to the internal disk,
the analyzer displays a message while
the save is in progress.

When you save to a data register,
RAM, or non-volatile RAM, the
operation speed does not allow the
message to be displayed. When the
softkey menu changes, the save is
complete.

Prev Topic-7      Print-8      Prev Page-^      Index-1
Jump To Topic-4  Help On Help-5  Next Page-v      Quit-0

```

To select a topic from the help index

- 1** Enter the online help system:
Press [**Help**].
- 2** Display the index:
Press [**1**].
- 3** Turn the knob to select the topic you want help on
or
for faster paging press and hold the up-arrow or down-arrow keys then use the knob to select a topic.
- 4** Display the topic:
Press [**4**].
- 5** Quit online help:
Press [**Help**].
or
Press [**0**].

The help index contains an alphabetical listing of all help topics. Most topics listed in the index describe the hardkeys and softkeys, but some are of a more general nature. These more general topics are only available via the index or via “links” from related topics. An example appears below—the “Front Panel Tour” topic is only available through the index or the “links”, not by pressing any hardkey or softkey.

You can select any topic in the index by scrolling to highlight it then pressing 4

```

Topic: Index of Topics

flat top Softkey (gate window)
Fonts
format disk Softkey
four grids Softkey
free run Softkey (trigger)
French softkey
freq counter Softkey
freq response Softkey
Frequency Hardkey
Frequency Points
Front Panel Tour
Full Softkey (BASIC display)
full span Softkey
-G-
gate dly step Softkey
gate length Softkey
gate on/off Softkey
gate time Softkey
gate window Softkey
German softkey
goto line Softkey

Prev Topic-7      Print-8      Prev Page-^      Index-1
Jump To Topic-4  Help On Help-5  Next Page-v      Quit-0

```

2

Making Simple Noise Measurements

This chapter shows you how to make typical noise measurements. In this example, we will be making random noise, band power noise, and signal to noise measurements.

To measure random noise

- 1 Initialize the analyzer:**
Press [**Preset**].
- 2 Select a power spectral density measurement:**
Press [**Measurement Data**], [PSD] (select **ch1** with a 2-channel analyzer).
- 3 Configure the measurement and display:**
Press [**Average**], [average **on**],
Press [num averages], 500, [enter],
Press [average type], [rms (video)],
Press [Return] (bottom softkey),
Press [fast avg **on**], [update rate], 100, [enter] to speed the measurement.
- 4 Start an averaged measurement:**
Press [**Meas Restart**].

The display should appear as shown below.

To learn more about the choices you make in this measurement, display online help for the various keys used (see “Using Online Help” if you are not familiar with how to do this).

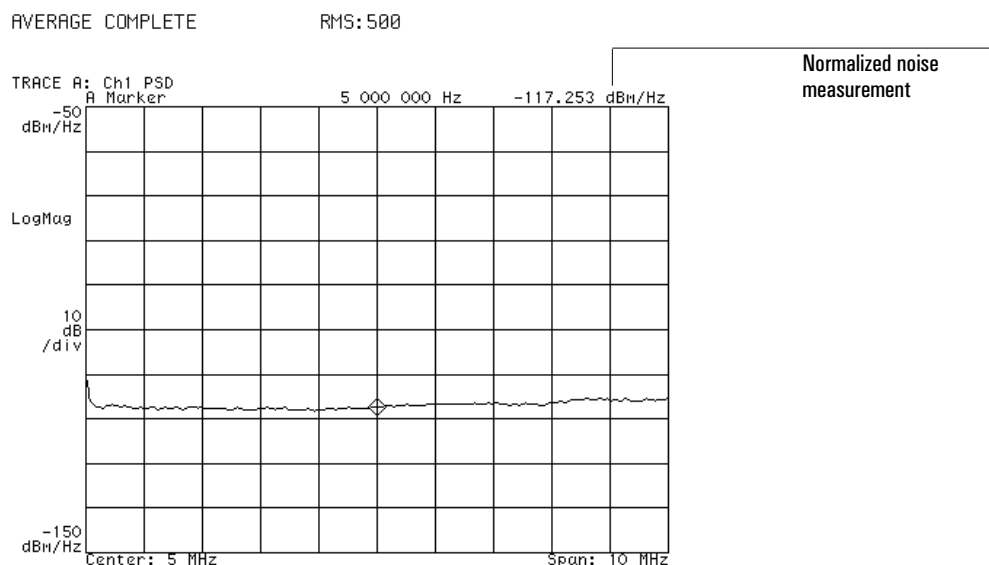

In this example you are measuring the noise-power of the analyzer’s noise floor. The displayed marker value reflects noise-power normalized to a 1-Hz bandwidth.

To measure band power

- 1** Initialize the analyzer:
Press **[Preset]**.
- 2** Select video averaging:
Press **[Average]**, **[average on]**,
Press **[num averages]**, **50**, **[enter]**,
Press **[average type]**, **[rms (video)]**
- 3** Start an averaged measurement:
Press **[Meas Restart]**.
- 4** Turn on the band power markers:
Press **[Marker Function]**, **[band power markers]**, **[band pwr mkr on]**, **[band power]**.
- 5** Change the width of the band:
Press **[band width]**, **[Marker | Entry]**,
then use the knob to change the width of the measurement band.
or
Press **[band width]**,
then enter the desired band width with the numeric entry keys.
The display should appear as below. The grid lines have been turned off to highlight the band power markers.

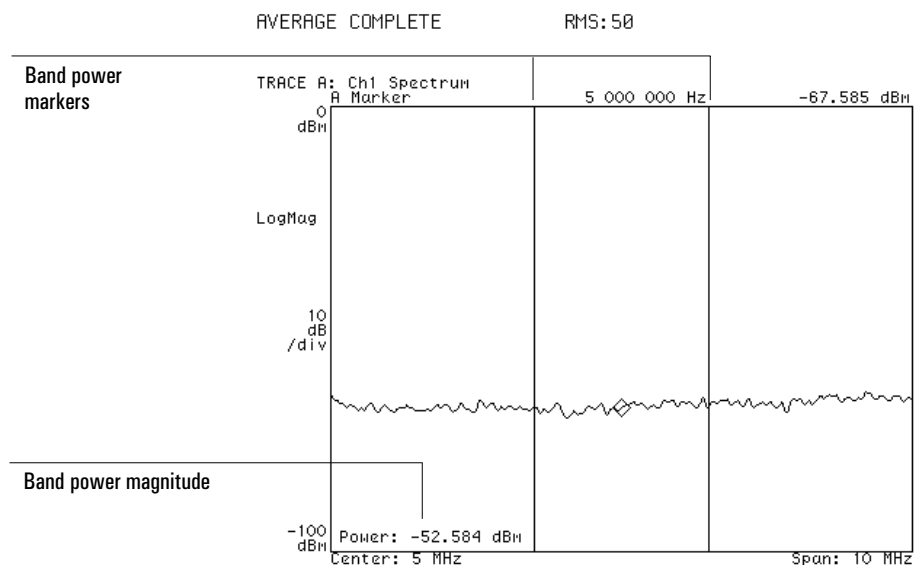

In this example you are measuring the power of the analyzer's noise floor within a defined band. The value displayed in the lower left corner of the display reflects the total power within the frequency band encompassed by the markers. The grid lines have been turned off to highlight the band power markers.

To measure signal to noise ratios

- 1 Initialize the analyzer:**
Press [**Preset**].
- 2 Supply a signal from the internal source:**
Connect the SOURCE output to the CHANNEL 1 input with a BNC cable.
Press [**Source**], [source **on**], [sine freq], 5, [MHz]
- 3 Place the marker on the signal peak:**
Press [**Marker**⇒], [marker to peak]
or
Press [**Shift**], [**Marker**]
- 4 Select video averaging:**
Press [**Average**], [average **on**].
- 5 Turn on the carrier-to-noise marker:**
Press [**Marker Function**], [band power markers], [band pwr mkr **on**], [power ratio **C/N**].
- 6 Press [**Marker**|**Entry**]**
Rotate the knob to move the measurement band from the signal to a noise area.
The display should appear as below. The grid lines have been turned off to highlight the band power markers.

Step 3 above illustrates that there are two ways to perform certain actions—by using the hardkey/softkey sequence or by using the short-cut shift/hardkey sequence.

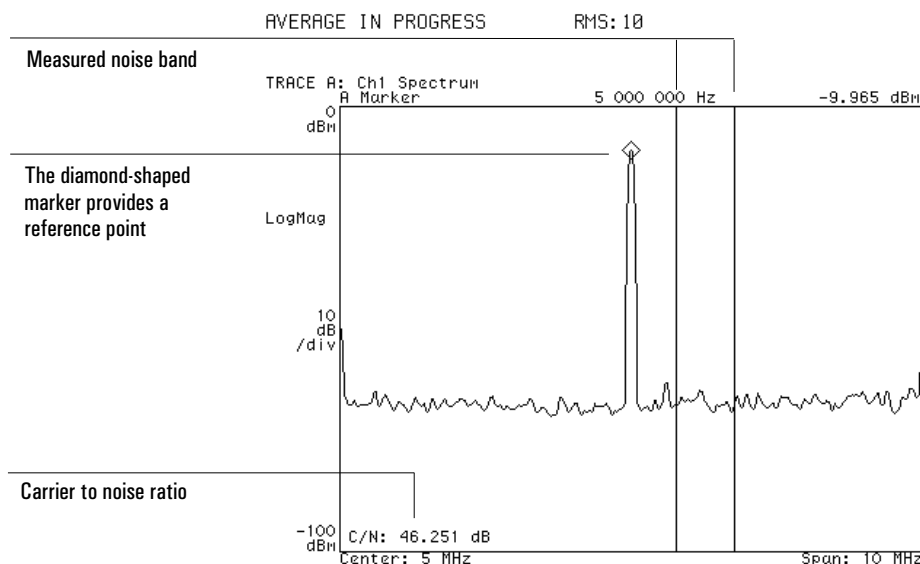

The value indicated in the lower left corner of the display reflects the difference between the marker level at the carrier peak and the total noise within the band markers.

7 Change to a normalized noise measurement:

Toggle to [power ratio **C/No**]

The display should appear as below. The grid lines have been turned off to highlight the band power markers.

The carrier-to-noise and carrier-to-normalized-noise marker measurements require that the standard (diamond shaped) marker be on the signal peak as a reference. If the marker is not on, the displayed value will only reflect the noise level.

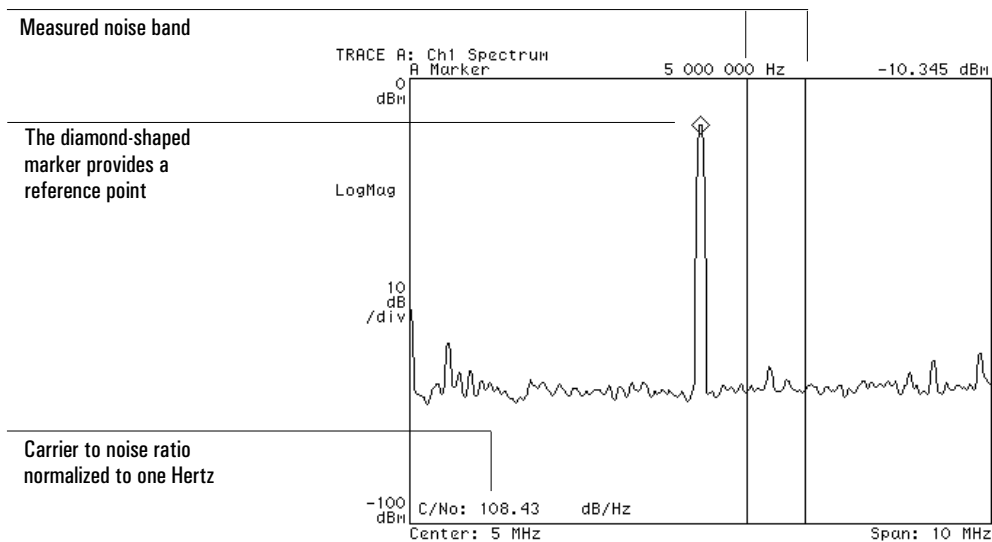

Now the value indicated in the lower left corner of the display reflects the difference between the marker level at the carrier peak and the noise-power within the band markers normalized to one Hertz bandwidth.

This type of measurement is often used to measure adjacent-channel power. Another method is shown on the following page.

You can perform band power measurements in either Vector or Scalar Mode. If you use Scalar mode and you have selected a combination of resolution bandwidth, window type, and number of frequency points such that the analyzer implements the detector, the analyzer will prompt you to select the sample detector in order to calculate the band power accurately.

To measure adjacent-channel power

This task shows an additional method of measuring adjacent-channel power. The method shown on the previous page is preferred when carriers are represented by a single tone. This second method is used when carriers are heavily modulated or are defined over a band.

- 1** Use the band power markers, as shown in “To measure band power” to perform an rms (video) averaged measurement of the desired band encompassing the carrier. Save the trace in a register, for example register D1.
- 2** Create a math function: $F1 = \text{SQRT}(\text{SPEC1} * \text{SPEC1} / \text{D1} * \text{D1})$. See “To create a math function.”
- 3** Move the band power markers to encompass the desired adjacent-channel and perform an rms averaged measurement.
- 4** Select the math function as measurement data:
Press [Measurement Data], [math func], [F1]
- 5** Start a new rms (video) average.
Press [Meas Restart],

In rms averaging the power spectrum is in linear units (volts), rather than power units, with its real part all positive and its imaginary part all zero. Therefore, the spectra must be squared for use in power calculations.

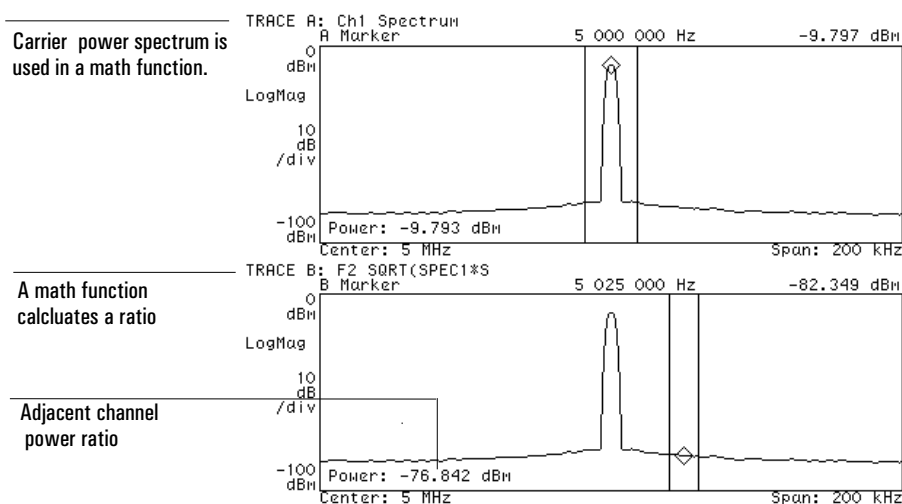

Band power markers and a math function are used to determine the ratio between the carrier and adjacent-channel power.

3

Using Gating to Characterize a Burst Signal

This chapter uses the time gating feature to analyze a multi-burst signal which is provided on the Signals Disk which accompanies the analyzer's *Operator's Guide*. Time gating allows you to isolate a portion of a time record for further viewing and analysis. For more details on time gating concepts see "Gating Concepts" in the *Operator's Guide*.

To Use Time Gating

First we'll look at the spectrum of the signal and see that three components exist. Then we'll look at the time display of the burst signal and analyze each burst separately to determine which spectral components exist in each burst.

1 Initialize the analyzer:

Press [**Preset**].

2 Load the source signal file BURST.DAT into data register D3:

Insert the Signals Disk in the analyzer's disk drive.

Press [**Save/Recall**], [default disk], [internal disk] to select the internal disk drive.

Press [Return] (bottom softkey), [catalog on] to display the files on the disk.

Rotate the knob until the file BURST.DAT is highlighted.

Press [recall trace], [from file into D3], [enter].

3 Connect the SOURCE output to the CHANNEL 1 input with a BNC cable.

4 Turn on the source and select arbitrary signal D3:

Press [**Source**], [source on], [source type], [arb data reg], [D3], [Return], [arbitrary].

Press [**Average**], [average on].

The display should now appear as shown below.

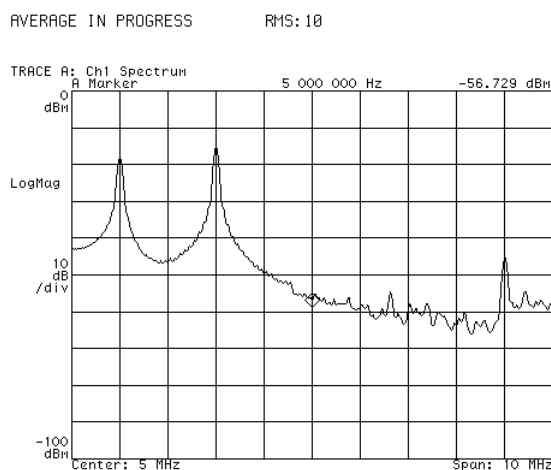

The spectrum with averaging turned on. Note existence of three components.

5 Configure the display and the measurement:

Press **[Display]**, [2 grids], [more display setup], [grids **off**].

Press **[B]**, **[Measurement Data]**, [main time] (toggle to **ch1** on a 2-channel analyzer).

Press **[Ref Lvl/Scale]**, [Y per div], 50, [mV].

Press **[Trigger]**, [trigger type], [internal source].

Press **[Time]**, [main length], 32, [us].

6 Set up the time gating and examine the first burst:

Press **[Time]**, [gate **on**], [gate length], 10, [us].

Press [ch1 gate dly], **[Marker|Entry]**

Rotate the knob until the gate is at each end of the first burst signal.

The display should now appear as shown to the left below.

7 Examine the second burst:

Rotate the knob until the gate is at each end of the second burst signal.

The display should now appear as shown to the right below.

Note that the **[Time]** menu must be displayed, the [gate delay] softkey active, and the knob in the **Entry** mode to move the gate by turning the knob.

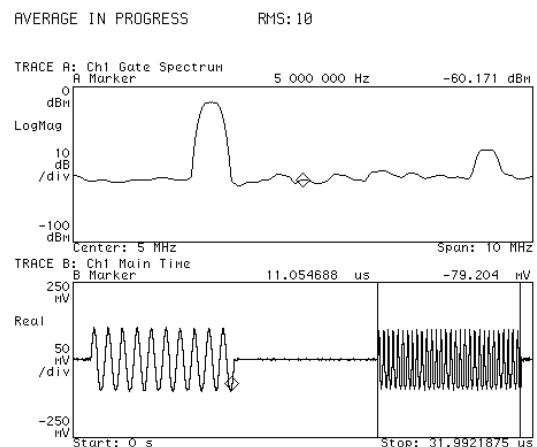
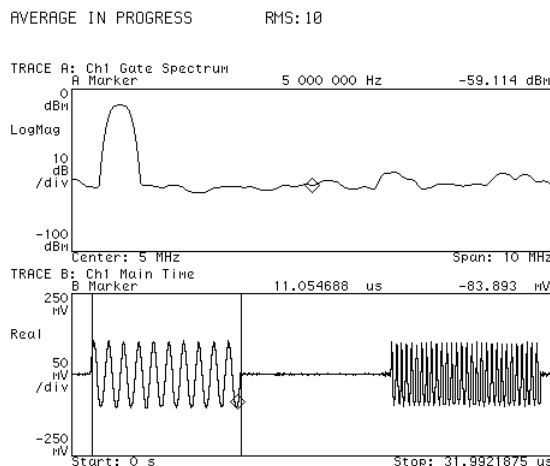

Spectrum (top trace) of the burst is derived by gating the time signal (bottom trace). The gate's delay and length are selected to encompass the burst signal (vertical markers show gate position). Note existence of the first spectral component in the left display and the existence of the other two components in the right display.

4

Measuring Relative Phase

This section shows you how to make typical relative phase measurements on modulated carrier signals. In this example, you measure the phase of sidebands on AM and PM signals relative to the carrier. The test signals are provided on the Signals Disk which accompanies the *Operator's Guide*.

To measure the relative phase of an AM signal

1 Initialize the analyzer:

Press [**Preset**].

2 Load AM and PM signals from the Signals Disk into registers and play the AM signal through the source:

Insert the Signals Disk in the internal disk drive.

Use the BNC cable to connect the SOURCE to the CHANNEL 1 input.

Press [**Save/Recall**], [default disk], [internal disk].

Press [Return], [catalog **on**].

Rotate the knob to highlight AMSIG.DAT

Press [recall trace], [from file into D1], [enter].

Rotate the knob to highlight PMSIG.DAT

Press [from file into D2] [enter].

Press [**Source**], [source **on**], [source type], [arbitrary].

3 Configure the measurement and display:

Press [**Frequency**], [span], 150, [kHz],

Press [**Trigger**], [trigger type], [internal source],

Press [**Sweep**], [single].

4 Activate a different trace as a phase display:

Press [**Display**], [2 grids],

Press [**B**], [**Measurement Data**], [spectrum] (select **ch1** with a 2-channel analyzer),

Press [**Data Format**], [phase **wrap**]

5 Start a single sweep:

Press [**Pause | Single**].

6 Activate two traces:

Press [Shift], [A] (two Active Trace LEDs are now turned on)

7 Turn on marker coupling and zero the offset marker on the carrier:

Press [Marker], [couple mkr on],

Press [Shift], [Marker] to place the marker on the carrier peak,

Press [Shift], [Marker⇒] to zero the offset marker.

8 Use the search marker to measure the phase of the two largest sidebands relative to the carrier:

Press [Marker Search], [next peak], and note the phase displayed for the lower trace.

Press [next peak] again and note the phase.

SINGLE SWEEP - PAUSED

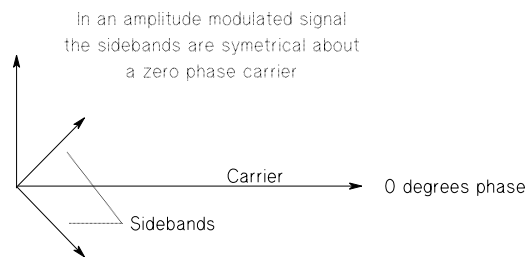
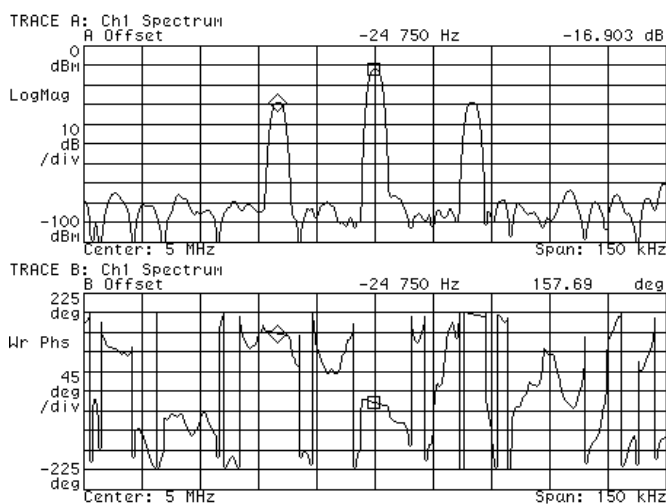

The phase values vary with each sweep but for an AM signal the average phase of the sidebands is equal to the carrier phase.

To measure the relative phase of an PM signal

Continue from “To measure the relative phase of an AM signal.”

- 1** Replace the arbitrary source AM signal with the PM signal in register D2:
Press [Source], [source type], [arb data reg], [D2].
- 2** Start a single sweep:
Press [Pause | Single].
- 3** Zero the offset marker on the carrier:
Press [Shift], [Marker],
Press [Shift], [Marker⇒]
- 4** Use the search marker to measure the phase of the two largest sidebands relative to the carrier:
Press [Marker Search], [next peak] and note the phase displayed for the lower trace.
Press [next peak] again and note the phase.

SINGLE SWEEP - PAUSED

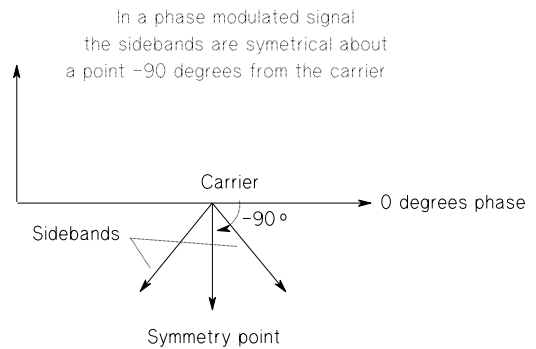
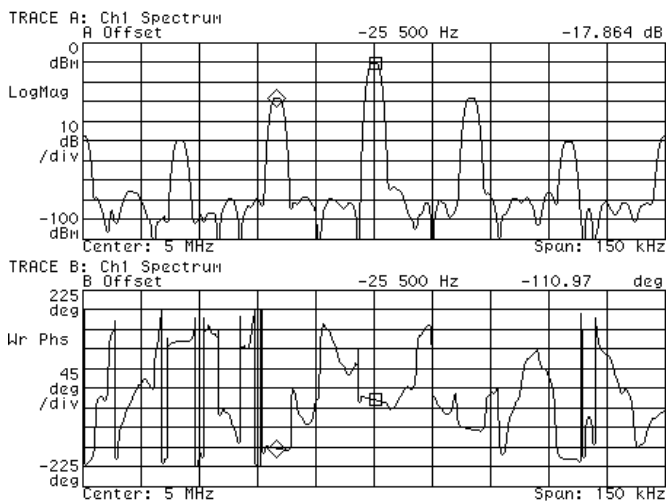

The phase values vary with each sweep but for a PM signal the average phase of the two sidebands is equal to -90 degrees from the carrier.

5

Characterizing a Filter

This section shows you how to make a typical network measurement. In this example, we will be characterizing a 4.5 MHz bandpass filter.

To set up a frequency response measurement

Note

This measurement can only be performed with a 2-channel analyzer—you must have option AY7.

- 1** Using a BNC “T” adapter or power splitter and BNC cables, connect the analyzer’s SOURCE to the CHANNEL 1 input directly and to the CHANNEL 2 input through a filter as shown in the illustration below.
- 2** Initialize the analyzer:
Press [**Preset**].
- 3** Configure the analyzer to make two-channel frequency response measurements:
Press [**Measurement Data**], [freq response].

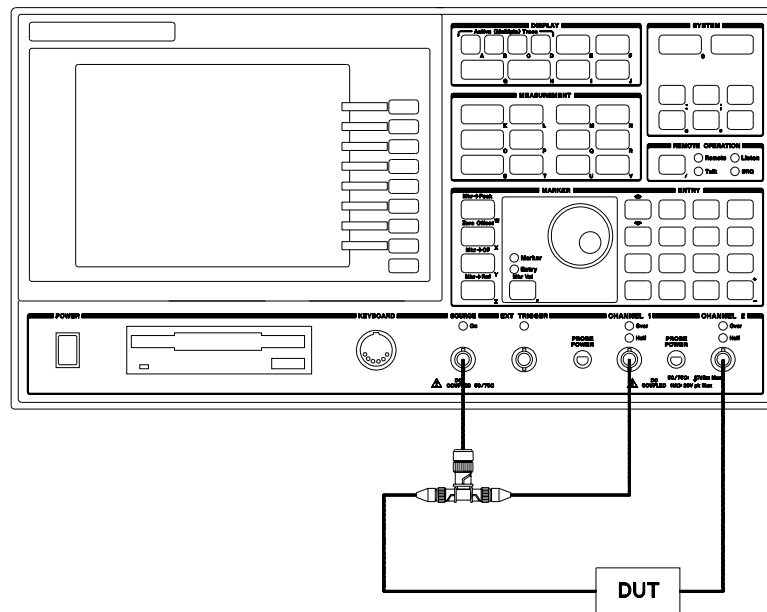

4 Configure the source and measurement for a frequency response measurement:

Press **[Source]**, [source on],
 Press [source type], [periodic chirp],
 Press [Return], (bottom softkey)
 Press [level], .5, [Vrms].

Press **[Res Bw/Window]**, [rbw mode arb],
 Press [main window], [uniform].

Press **[Range]**, [channel both], [ch* single range up-down].

Press **[Average]**, [average on]
 Press [num averages], 50, [enter],
 Press [average type], [rms (video)].

Press **[Auto Scale]**.

5 Start an averaged measurement:

Press **[Meas Restart]**.

The display should appear similar to that shown below. To learn more about the choices you make in this measurement, display online help for the various keys used (see “Using Online Help” if you are not familiar with how to do this).

Note the distinction between selecting the range (the sensitivity of the analyzer’s input circuitry) and selecting the scale (the positioning of the data on the display).

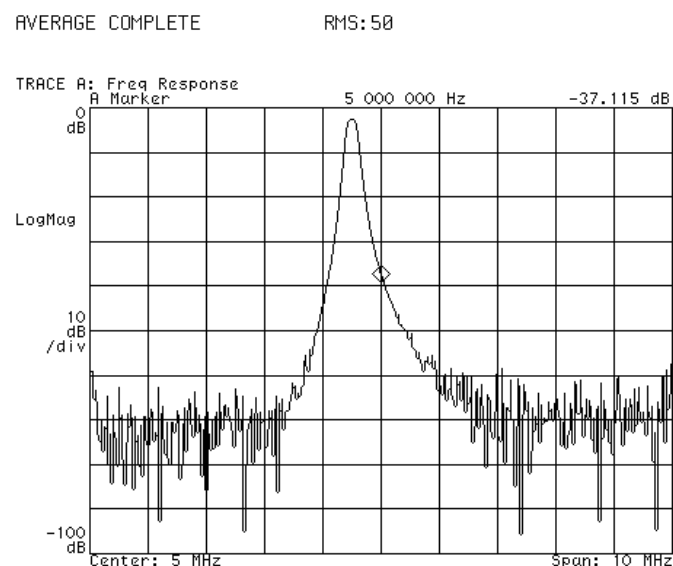

Frequency response data displays the output of a device-under-test divided by the input

To use the absolute marker

Continue from “To set up a frequency response measurement.”

- 1** Move the marker to the largest part of the frequency response trace:
Press [**Marker**⇒], [marker to peak].
or
Press [**Shift**], [**Marker**]
- 2** Move the marker with the knob to view the absolute gain/loss of this particular filter network at different frequencies.

Note that there are two ways to perform some functions. In this example you may move the marker to the highest point on the trace by selecting the function in a softkey menu or by using a shift function.

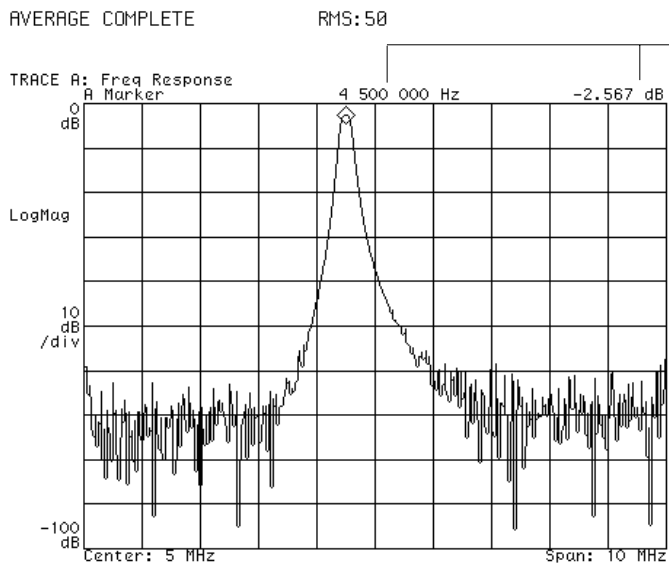

The frequency and amplitude of the trace at the marker location are shown at the top of the display

The marker reflects the absolute amplitude and frequency

To use the relative marker

Continue from “To set up a frequency response measurement” or from “Using the absolute marker.”

- 1 Move the marker to the largest part of the frequency response trace if it is not already there:

Press **[Shift]**, **[Marker]**.

- 2 Establish the reference point for the relative (offset) marker:

Press **[Marker]**, [zero offset]

or

Press **[Shift]**, **[Marker⇒]**.

- 3 Move the marker with the knob to view the relative gain/loss of this particular filter at different frequencies.

The offset marker allows you to establish a reference point with the square-shaped marker. As you move diamond-shaped marker, the value displayed by the marker readout reflects the difference between the reference point and the marker.

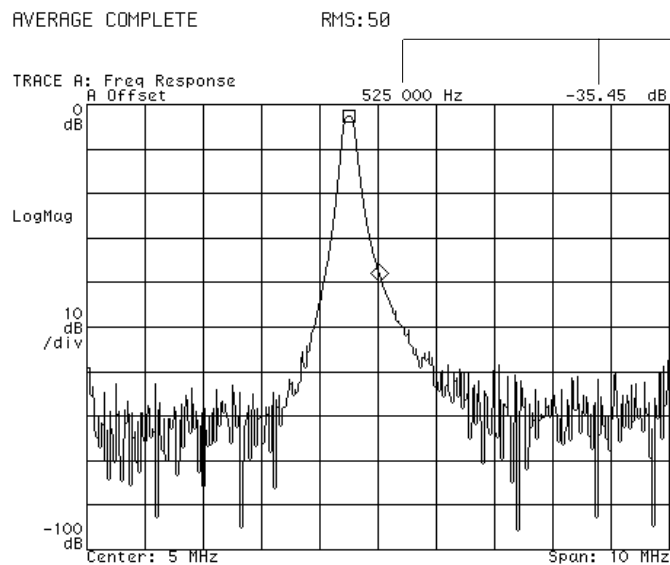

The marker frequency and amplitude reflect the value of the diamond-shaped marker relative to the offset (square) marker

The marker reflects the amplitude and frequency relative to the reference point

To use the search marker

Complete “To set up a frequency response measurement” or continue from one of the previous marker measurements.

- 1 Move the marker to the largest part of the frequency response trace if it is not already there:

Press [Shift], [Marker].

- 2 Activate and zero the relative marker if it is not already activated:

Press [Shift], [Marker⇒].

- 3 Define the search target level and perform a search:

Press [Marker Search], [search setup],

Press [search target], -6, [dB],

Press [search right], [search left].

The search marker allows you to quickly find a target value. When the offset marker is activated the target value is relative to the reference point.

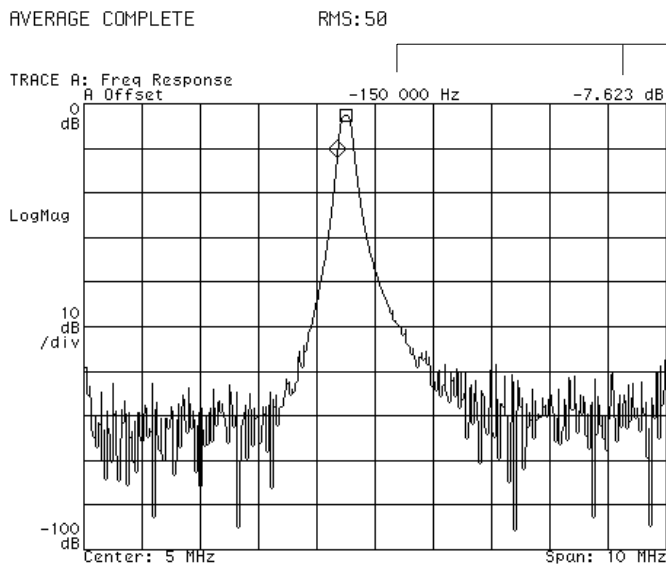

With the offset marker activated, the search marker indicates the point on the trace which is separated from the offset marker by the target value

The search marker finds a Y-axis value with reference to a target value

To display phase

Complete “To set up a frequency response measurement” or continue from one of the previous marker measurements.

- 1** Display a second trace:
Press **[Display]**, [2 grids].
- 2** Activate the second trace and define it as a frequency response measurement:
Press **[B]**, **[Measurement Data]**, [frequency response].
- 3** Specify phase data for the second trace:
Press **[Data Format]**, [phase wrap].
- 4** Couple the markers on traces A and B:
Press **[Marker]**, [couple mkrs on].
- 5** Move the markers with the knob to determine phase with respect to frequency response.
- 6** Overlap the two traces:
Press **[Shift]**, **[A]**.
Press **[Display]**, [single grid].

In this example, note that a trace which is displayed is not necessarily active (capable of being configured). You must specifically activate a displayed trace in order to change its configuration. For example, if you have chosen the relative marker in one trace then couple the markers, the marker on the second trace will be absolute, rather than relative, unless you activate the second trace and select the relative marker.

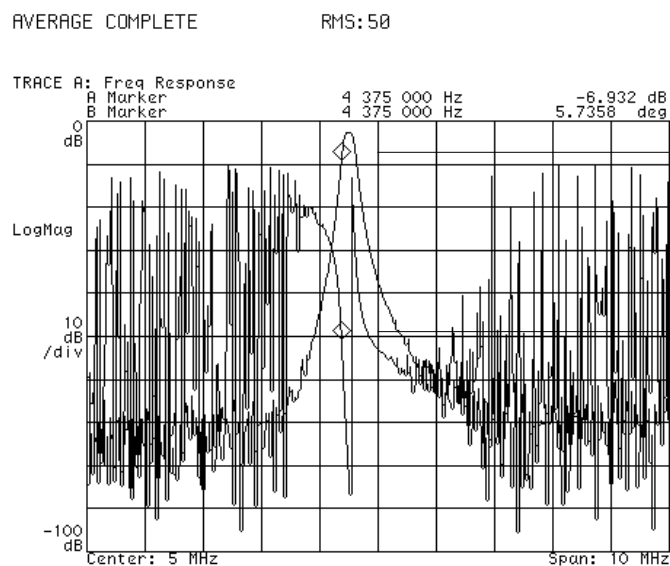

To display coherence

Complete “To set up a frequency response measurement” or continue from one of the previous measurements.

- 1 Display a second trace:
Press [**Display**], [2 grids].
- 2 Activate the second trace and select a coherence measurement:
Press [**B**], [**Data Format**], [magnitude **linear**], [**Measurement Data**], [more choices], [coherence].

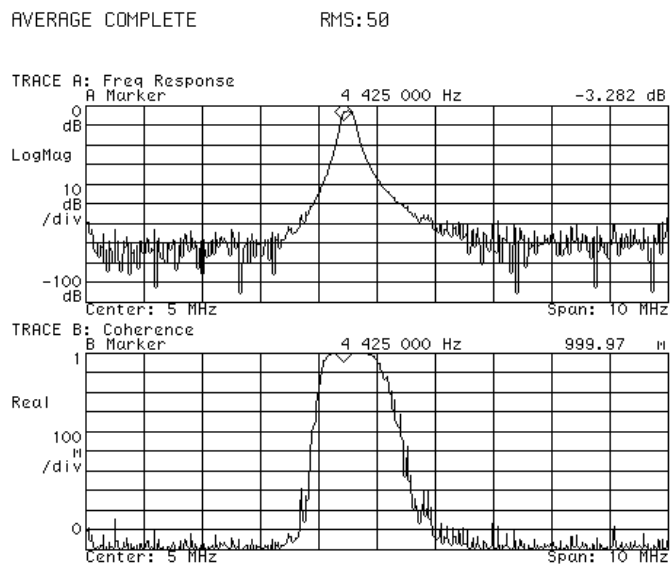

Coherence indicates the statistical validity of a frequency response measurement

6

General Tasks

This chapter shows you how to perform various common tasks. These include setting up and using peripherals and defining and using math functions.

To set up peripherals.

You may connect peripherals to four ports—one GPIB port, two serial ports, and one parallel port. GPIB peripherals may include printers, plotters, and external disk drives. Supported serial devices are plotters and printers. Certain printers are parallel devices.

- 1** Connect the ports of your peripheral and analyzer with the correct cables. See “Preparing the Analyzer for Use” for information on physical connections.
- 2** Turn on the peripherals.
- 3** Set up GPIB peripherals:
 Determine the address of the peripheral from your peripheral’s documentation
 Use this as <num> below.
 On the analyzer, press [**Local/setup**], [peripheral addresses].
 Press the softkey corresponding to your device type.
 Press <num>, [enter].
 Repeat this step for each GPIB peripheral.
- 4** Set up serial peripherals:
 Refer to your serial device’s documentation to select correct setup parameters.
 Press [Serial 1 setup] or [Serial 2 setup] and enter the correct parameters.

Note that the parallel interface requires no special setup.

Display online help for more details on setup and parameter choices.

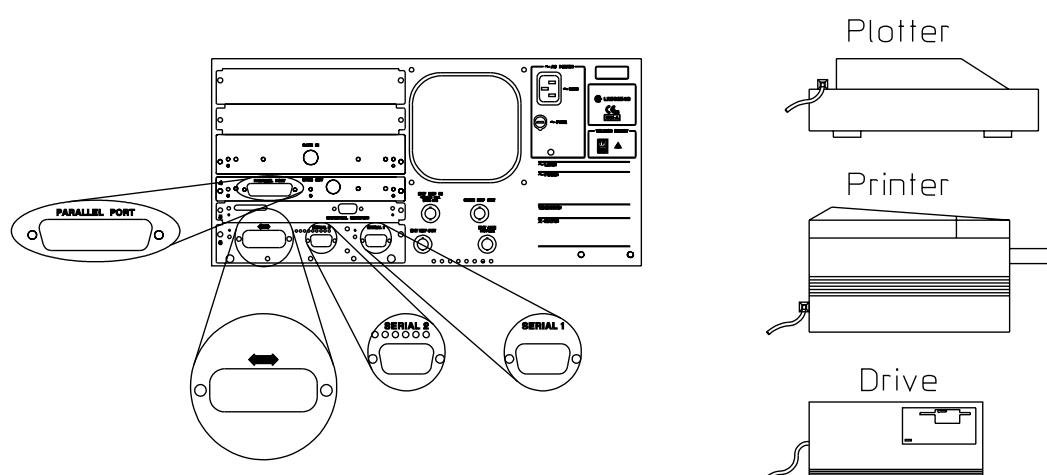

To print or plot screen contents

- 1** Set up your printer or plotter if you haven't already done so.
- 2** Select the output format and device type:
Press **[Plot/Print]**, [output fmt] and select the desired format.
Press [device defaults] and select a device if you want other than the default.
- 3** Select the type of output port:
Press **[Plot/Print]**, [output to] and select the port to which your printer or plotter is attached.
- 4** Press **[Local/Setup]**, [system controller].
- 5** Press **[Plot/Print]**, [start plot/print]

The analyzer is only able to initiate printing or plotting if it is attached to a printer or plotter and is designated as the system controller. If you haven't already set up your printer or plotter, see "To set up peripherals." All of the screen's contents, except the softkey labels, are printed when you complete this task.

You may select various parameters under the [plot item] and [plot/print setup] softkeys depending on your particular peripheral. To learn more about these parameters, display online help for the relevant softkeys.

The image shows a spectrum analyzer screen with the following text and elements:

- Top left: TRACE A: Ch1 Spectrum
- Top center: A Marker 6 500 000 Hz
- Top right: -76.873 dBm
- Left side: 0 dBm, LogMag, 10 dB/div, -100 dBm
- Bottom left: Center: 5 MHz
- Bottom right: Span: 10 MHz
- Right side softkeys:
 - start plot/print
 - abort
 - output fmt [PCL] →
 - output to [file] →
 - plot item [all disp] →
 - plot/print setup →

Annotations on the right side:

- A dashed box around the "plot item" softkey is connected by a line to the text: "With a plotter, you can elect to plot portions of the display"
- A line connects the "plot/print setup" softkey to the text: "You can control certain device options, depending on your output device"

You must use the PLOT/PRINT menu to select the correct type of device and port before starting a plot or print of the screen contents.

To save data with an internal or RAM disk

You may save trace data, instrument states, trace math functions, instrument BASIC programs, and time-capture buffers.

1 Select the default disk:

Press [**Save/Recall**], [default disk]

Press [nonvolatile RAM disk], [volatile RAM disk] or [internal disk]

2 Press [Return].

3 Press the softkey that matches the type of data you want to save (then select a storage register if you are saving a trace).

4 Enter the file name if you have chosen to save to a file:

Use the hardkeys (which have now been remapped to represent the symbols etched to the lower right of them), softkeys, knob, and numeric keys to type in a file name.

5 Press [enter].

For more information on the softkeys and parameter choices, display online help.

If you are using the internal disk drive, you must insert a formatted 3.5-inch flexible disk into the analyzer's internal disk drive. If you want to save data but the disk has not been previously formatted see "To format a disk."

To recall data with an internal or RAM disk

You may recall trace data, instrument states, trace math functions, instrument BASIC programs, and time-capture buffers.

1 Select the default disk:

Press **[Save/Recall]**, [default disk]

Press [nonvolatile RAM disk], [volatile RAM disk] or [internal disk]

2 Press [Return].

3 To easily recall a file you may press [catalog **on**] to display the names of files stored on the disk then use the knob to scroll to the desired file.

4 Press the softkey that matches the type of data you want to recall (then select a storage register if you are recalling a trace).

5 If you have not selected a file name from the catalog, enter the file name:

Use the hardkeys (which have now been remapped to represent the symbols etched to the lower right of them), softkeys, knob, and numeric keys to type in a file name.

6 Press [enter].

For more information on the softkeys and parameter choices, display online help.

To format a disk

1 Select the disk drive you want to format:

Press **[Disk Utility]**, [default disk]

Press the softkey corresponding to the disk drive you want to format.

2 Press [Return], [format disk].

Select appropriate parameters for your disk drive (disk type, interleave etc.).

3 Press [perform format], [proceed].

You may format 3.5-inch disks in the internal disk drive. They must be double-sided, high-density flexible disks that are not write-protected.

The analyzer may take a few minutes to format a disk (depending on the type of disk) and is unavailable for other tasks during that time.

Caution

You can damage both the disk and the drive if you attempt to eject a disk when the “Format disk in progress” message is displayed or when the disk’s “busy” light is on.

To create a math function

In this section you learn how to create a math function which inverts a signal.

1 Initialize the analyzer:

Press **[Preset]**

2 Define a constant:

Press **[Math]**, **[define constant]**, **[define K1]**

Press **[real part]**, **1**, **[enter]**, **[imag part]**, **0**, **[enter]**.

3 Define a math function:

Press **[Math]**, **[define F1]**

[constant], **[K1]**, **[/]**, **[meas data]**, **[spectrum]** **[enter]**.

A math function remains in memory through a Preset but will be erased when you power down the analyzer. If you want to preserve the math function for future use, save it in the non-volatile RAM or on an internal disk.

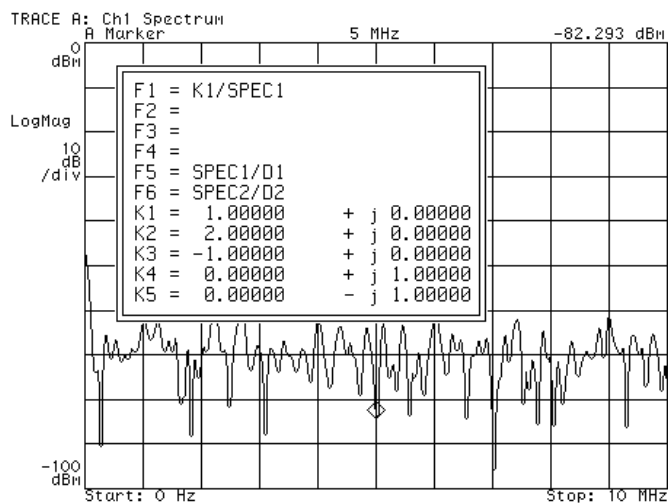

You can create up to 6 functions and 5 constants

To use a math function

In this section you learn how to apply a math function to a signal. This task assumes that you have completed “To create a math function.”

- 1 Initialize the analyzer:**
Press [**Preset**]
- 2 Provide an averaged signal from the internal source:**
Connect the SOURCE to the CHANNEL 1 input with a BNC cable
Press [**Source**], [source on], [**Average**], [average on].
- 3 Apply the inversion math function you created to this signal:**
Press [**Measurement Data**], [math func], [F1].
- 4 Press [**Auto Scale**].**

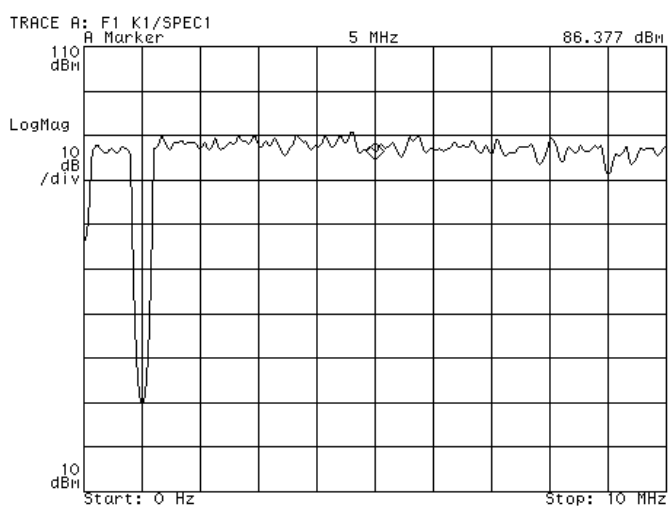

A user-created math function is applied to a signal

To display a summary of instrument parameters

1 Press **[View State]**.

2 Press **[measurement state]** or **[input/source state]**.

These summaries reflect the current states of important measurement, input, and source parameters. You may use these summaries to:

- quickly check the current setup
- document the setup (The list can be printed or plotted.)

You will note that the contents of the measurement state differ depending on the instrument mode. This reflects the fact that some parameters are not used for a particular instrument mode.

MEASUREMENT STATE			
Inst Mode	Vector	Channels	2
	Meas from input		
Freq	Start	0 Hz	Center 5 MHz
	Stop	10 MHz	Span 10 MHz
Res Bw/ Window	Rbw	377.51 kHz	Rbw coupling fixed
	Rbw mode	arb	Time len 10.117 us
	Window	flat top	Num freq pts 401
MainTime	Ch1 delay	0 s	Width 32.031 us
	Ch2 delay	0 s	Gate on
GateTime	Ch1 delay	21.25 us	Width 10.117 us
	Ch2 delay	0 s	
Average	Status	on	Num averages 10
	Type	rms expo	Repeat avg off
	Overlap	0 %	Fast avg off
Press [View State] > [Off] to turn off this table			

INPUT/SOURCE STATE			
Range/ Input	-- Channel 1 --	-- Channel 2 --	
	Status	on	Status off
	Range	0 dBm	Range 0 dBm
	Autorange	off	Autorange off
	Input Z	50 Ohm	Input Z 50 Ohm
	IM imped	50 Ohm	IM imped 50 Ohm
	Coupling	AC	Coupling AC
	Alias LPF	in	Alias LPF in
Trigger	Type	int source	Level 0 V
	Slope	+	
	Ch1 delay	0 s	Ch2 delay 0 s
	Ext arm	off	Arm level 0 V
	Arm slope above	Arm delay 0 s	
Source	Status	on	Level -20 dBVpk
	Type	arbitrary	Sine freq 1 MHz
	Output Z	50 Ohm	DC offset 0 V
Press [View State] > [Off] to turn off this table			

State summaries provide a quick view of the instrument setup parameters

7

Preparing the Analyzer for Use

Preparing the Analyzer for Use

This chapter contains instructions for inspecting and installing the HP 89410A DC-10 MHz Vector Signal Analyzer. This chapter also includes instructions for cleaning the screen, transporting and storing the analyzer.

Power Requirements

The analyzer can operate from a single-phase ac power source supplying voltages as shown in the table. With all options installed, power consumption is less than 750 VA.

AC Line Voltage	
Range	Frequency
90-140 Vrms	47-440 Hz
198-264 Vrms	47-63 Hz

The line-voltage selector switch is set at the factory to match the most commonly used line voltage in the country of destination; the appropriate fuse is also installed. To check or change either the line-voltage selector switch or the fuse, see "To change the line-voltage selector switch" or "To change the fuse."

Warning

Only a qualified service person, aware of the hazards involved, should measure the line voltage.

Caution

Before applying ac line power to the analyzer, ensure the line-voltage selector switch is set for the proper line voltage and the correct line fuse is installed in the fuse holder.

Power Cable and Grounding Requirements

On the GPIB connector, pin 12 and pins 18 through 24 are connected to chassis ground and the GPIB cable shield. The instrument frame, chassis, covers, and the BNC connectors' outer shell for the source, trigger, channel 1, and external arm are connected to chassis ground. If option AY7 (second input channel) is installed, the channel 2 BNC connector's outer shell is connected to chassis ground. If option AY5 (precision frequency reference) is installed, the oven reference output BNC connector's outer shell is connected to chassis ground.

Warning

DO NOT interrupt the protective earth ground or “float” the Agilent 89410A DC-10 MHz Vector Signal Analyzer. This action could expose the operator to potentially hazardous voltages.

The analyzer is equipped with a three-conductor power cord which grounds the analyzer when plugged into an appropriate receptacle. The type of power cable plug shipped with each analyzer depends on the country of destination. The following figure shows available power cables and plug configurations.

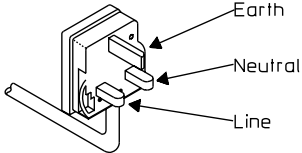
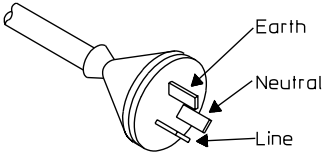
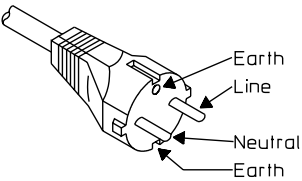
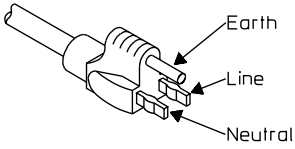
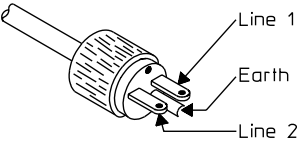
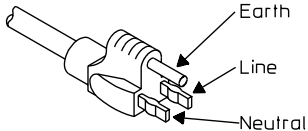
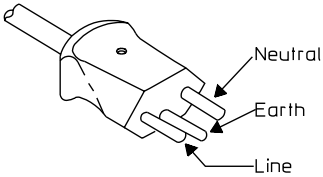
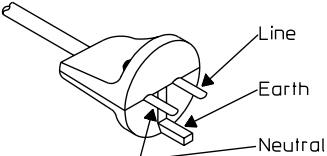
<p>United Kingdom Option 900</p>  <p>PLUG*: BS 1363A CABLE*: P/N 8120-1351</p> <p>220V-5A OPERATION</p>	<p>Australia/New Zealand Option 901</p>  <p>PLUG*: NZSS 198/AS C112 CABLE*: P/N 8120-1369</p> <p>220V-6A OPERATION</p>
<p>Continental Europe Option 902</p>  <p>PLUG*: CEE7-V11 CABLE*: P/N 8120-1689</p> <p>220V-6A OPERATION</p>	<p>North America Option 903</p>  <p>PLUG*: NEMA 5-15P CABLE*: P/N 8120-1378</p> <p>125V-10A** OPERATION</p>
<p>North America Option 904</p>  <p>PLUG*: NEMA-6-15P CABLE*: P/N 8120-0698</p> <p>250V-6A** OPERATION</p>	<p>Japan Option 918</p>  <p>PLUG*: MITI 41-9692 CABLE*: P/N 8120-4753</p> <p>125V-12A OPERATION</p>
<p>Switzerland Option 906</p>  <p>PLUG*: SEV 1011.1959-24507 TYPE 12 CABLE*: P/N 8120-2104</p> <p>220V-6A OPERATION</p>	<p>Denmark Option 912</p>  <p>PLUG*: DHCR 107 CABLE*: P/N 8120-2956</p> <p>220V-6A OPERATION</p>

*The number shown for the plug is the industry identifier for the plug only, the number shown for the cable is an Agilent part number for a complete cable including the plug.

**UL listed for use in the United States of America.

Warning

The power cable plug must be inserted into an outlet provided with a protective earth terminal. Defeating the protection of the grounded analyzer cabinet can subject the operator to lethal voltages.

To do the incoming inspection

The Agilent 89410A DC-10 MHz Vector Signal Analyzer was carefully inspected both mechanically and electrically before shipment. It should be free of marks or scratches, and it should meet its published specifications upon receipt.

- 1** Inspect the analyzer for physical damage incurred in transit. If the analyzer was damaged in transit, do the following:
 - Save all packing materials.
 - File a claim with the carrier.
 - Call your Agilent Technologies sales and service office.

Warning

If the analyzer is mechanically damaged, the integrity of the protective earth ground may be interrupted. Do not connect the analyzer to power if it is damaged.

- 2** Check that the line-voltage selector switch on the analyzer's rear panel is set for the local line voltage.

The line-voltage selector switch is set at the factory to match the most commonly used line voltage in the country of destination. To change the line-voltage selector switch, see "To set the line-voltage selector switch."
- 3** Check that the correct line fuse is installed in the fuse holder.

The fuse is installed at the factory for the most commonly used line voltage in the country of destination. An 8 amp, 250 volt, normal blow fuse is required if the selector switch is set at 115 and a 4 amp, 250 volt, normal blow fuse is required if the selector switch is set at 230. For instructions on removing the fuse or fuse part numbers, see "To change the fuse."
- 4** Using the supplied power cord, plug the analyzer into an appropriate receptacle.

The analyzer is shipped with a three-conductor power cord that grounds the analyzer when plugged into an appropriate receptacle. The type of power cable plug shipped with each analyzer depends on the country of destination.

5 Set the analyzer's power switch to on.

Press the "I" symbol end of the rocker-switch located on the analyzer's lower left-hand corner. The analyzer requires about 15 seconds to complete its power-on routine.

6 Test the electrical performance of the analyzer using the operation verification or the performance tests in chapter 2, "Verifying Specifications" in the analyzer's *Installation and Verification Guide*.

The operation verification tests verify the basic operating integrity of the analyzer; these tests take about two hours to complete and are a subset of the performance tests. The performance tests verify that the analyzer meets all the performance specifications; these tests take about three hours to complete.

To install the analyzer

The analyzer is shipped with plastic feet in place, ready for use as a portable bench analyzer. The plastic feet are shaped to make full-width modular instruments self-align when they are stacked.

- **Install the analyzer to allow free circulation of cooling air.**
Cooling air enters the analyzer through the rear panel and exhausts through both sides.

Warning

To prevent potential fire or shock hazard, do not expose the analyzer to rain or other excessive moisture.

- **Protect the analyzer from moisture and temperatures or temperature changes that cause condensation within the analyzer.**
The operating environment specifications for the analyzer are listed in the *Agilent 89410A Technical Data* publication in the beginning of the *Installation and Verification Guide*.

Caution

Use of the equipment in an environment containing dirt, dust, or corrosive substances will drastically reduce the life of the disk drive and the flexible disks. The flexible disks should be stored in a dry, static-free environment.

- **To install the analyzer in an equipment cabinet, follow the instructions shipped with the rack mount kits.**

To change the line-voltage selector switch

The line-voltage selector switch is set at the factory to match the most commonly used line voltage in the country of destination.

- 1** Unplug the power cord from the analyzer.
- 2** Slide the line voltage selector switch to the proper setting for the local line voltage.
- 3** Check to see that the proper fuse is installed. See “To change the fuse.”

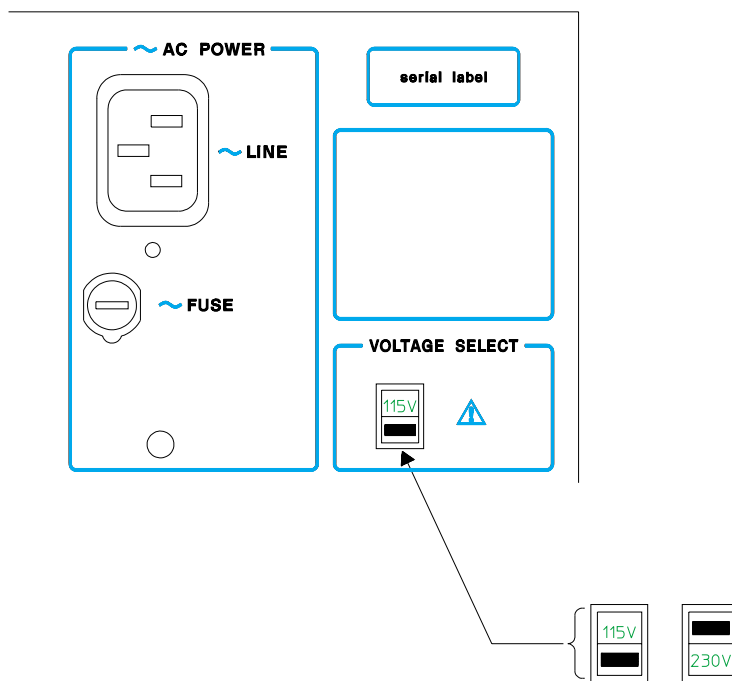

AC Line Voltage		Voltage Select Switch
Range	Frequency	
90-140 Vrms	47-440 Hz	115
198-264 Vrms	47-63 Hz	230

Warning

Only a qualified service person, aware of the hazards involved, should measure the line voltage.

To change the fuse

The fuse is installed at the factory to match the most commonly used line voltage in the country of destination.

- 1 Unplug the power cord from the analyzer.
- 2 Using a small screw driver, press in and turn the fuse holder cap counter-clockwise. Remove when the fuse cap is free from the housing.

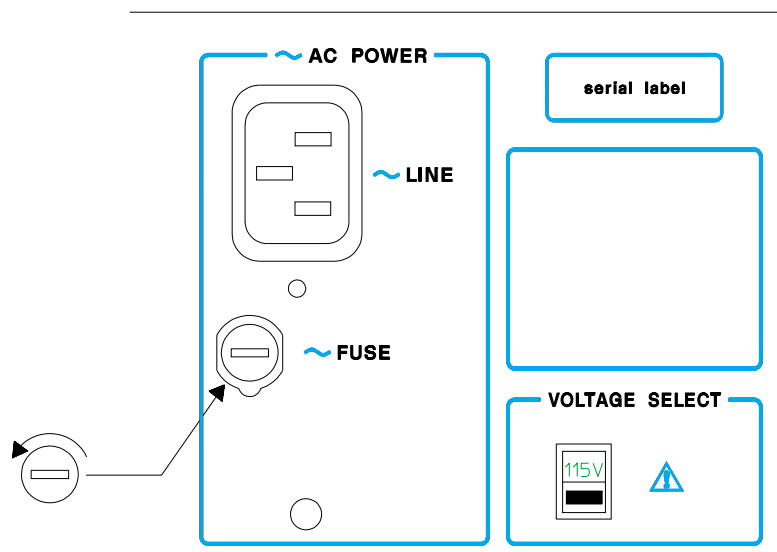

- 3 Pull the fuse from the fuse holder cap.
- 4 To reinstall, select the proper fuse and place in the fuse holder cap.

AC Line Voltage		Voltage Select Switch	Fuse	
Range	Frequency		Agilent Part Number	Type
90-140 Vrms	47-440 Hz	115	2110-0342	8 A 250 V Normal Blow
198-264 Vrms	47-63 Hz	230	2110-0055	4 A 250 V Normal Blow

- 5 Place the fuse holder cap in the housing and turn clockwise while pressing in.

To connect the analyzer to a LAN

Analyzers with option UFG, 4 megabyte extended RAM and additional I/O, have a ThinLAN and AUI (attachment unit interface) port for connecting the analyzer to the LAN (local area network).

- 1** Set the power switch to off (**O**).
- 2** Connect the ThinLAN BNC cable to the ThinLAN port or the appropriate media access unit (MAU) to the AUI port.
- 3** Set the power switch to on (**I**).
- 4** Press the following keys:
 - [**Local/Setup**]
 - [LAN port setup]
 - [port select ThinLAN (BNC)] or [port select AUI (MAU)]
 - [IP address]
 - internet protocol address
 - [**Return**]
 - [LAN power-on active]

See your LAN system administrator for the internet protocol address. Your LAN system administrator can also tell you if you need to set the gateway address or subnet mask.

To connect the analyzer to a serial device

The Serial 1 and Serial 2 ports are identical, 9-pin, EIA-574 ports. Both ports can interface with printers or plotters. The total allowable transmission path length is 15 meters.

- Connect the analyzer to plotters or printers using a 9-pin female to 25-pin RS-232-C cable.

Part Number	Cable Description
Agilent 24542G	9-pin female EIA-574 to 25-pin male RS-232
HP 24542H	9-pin female EIA-574 to 25-pin female RS-232

For additional information, see the *Service Guide*.

To connect the analyzer to a parallel device

The Parallel Port is a 25-pin, Centronics port. The Parallel Port can interface with PCL printers or HP-GL plotters.

- Connect the analyzer's rear panel PARALLEL PORT connector to a plotter or printer using a Centronics interface cable.

For additional information, see the *Service Guide*.

To connect the analyzer to an GPIB device

The analyzer is compatible with the General Purpose Interface Bus (GPIB). Total allowable transmission path length is 2 meters times the number of devices or 20 meters, whichever is less. Operating distances can be extended using an GPIB Extender.

Analyzers with option UFG, 4 megabytes extended RAM and additional I/O, have an additional GPIB connector. The additional GPIB connector, SYSTEM INTERCONNECT, is only for connection to the spectrum analyzer used with the Agilent 89411A 21.4 MHz Down Converter.

- Connect the analyzer's rear panel GPIB connector to an GPIB device using an GPIB interface cable.

Caution

The analyzer contains metric threaded GPIB cable mounting studs as opposed to English threads. Use only metric threaded GPIB cable lockscrews to secure the cable to the analyzer. Metric threaded fasteners are black, while English threaded fasteners are silver.

For GPIB programming information, see the *Agilent 89400 Series GPIB Command Reference*.

To connect the analyzer to an external monitor

The External Monitor connector is a 15-pin connector with standard VGA pinout. The External Monitor connector can interface with an external, multi-scanning monitor. The monitor must have a 25.5 kHz horizontal scan rate, a 60 Hz vertical refresh rate, and must conform to EIA-343-A standards.

- **Connect the analyzer's rear panel EXTERNAL MONITOR connector to an external monitor using an appropriate cable.**
For additional information, see EXTERNAL MONITOR in the analyzer's online help or the *Service Guide*.

To connect an external frequency reference

The analyzer may be connected to an external 1, 2, 5, or 10 MHz frequency reference. The amplitude of the 10 MHz external frequency reference must be between -3 dB and $+20$ dB into 50 ohms.

- **Using a BNC cable, connect the external frequency reference to the rear panel EXT REF IN connector.**
The analyzer uses its internal frequency reference if an external frequency reference or the optional OVEN REF OUT is not connected to EXT REF IN.

To connect the optional frequency reference

The analyzer may be connected to the precision frequency reference (option AY5). The precision frequency reference is a 10 MHz high stability frequency reference with an amplitude of approximately +5 dBm. For ease of upgrading, the OVEN REF OUT connector is installed even when option AY5 is not installed. To determine if the option is installed, press [**System Utility**] [option setup].

- Connect OVEN REF OUT to EXT REF IN using the supplied coax BNC-to-coax BNC connector (Agilent part number 1250-1499).
The analyzer uses its internal frequency reference if OVEN REF OUT or an external frequency reference is not connected to EXT REF IN.

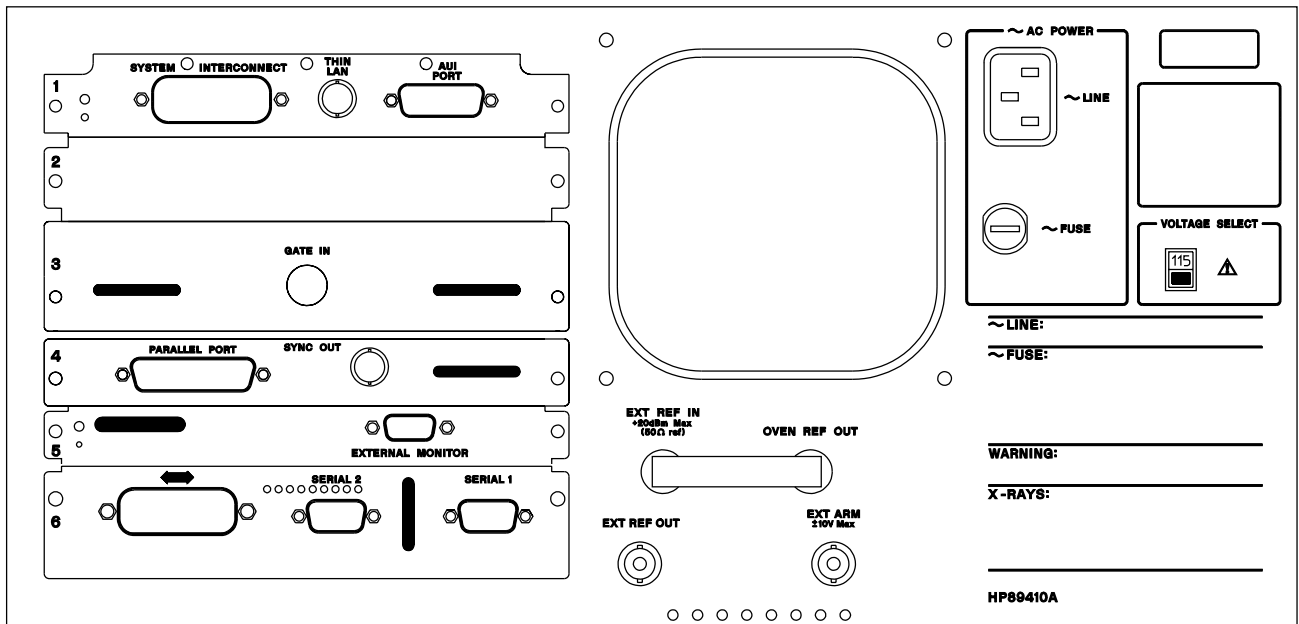

To connect the optional keyboard

The analyzer may be connected to an optional external keyboard. The keyboard remains active *even when the analyzer is not in alpha entry mode*. This means that you can operate the analyzer using the external keyboard rather than the front panel. Pressing the appropriate keyboard key does the same thing as pressing a hardkey or a softkey on the analyzer's front panel.

- 1** Set the power switch to on (I).
- 2** Connect the round plug on the keyboard cable to the **KEYBOARD** connector on the analyzer's front panel. Make sure to align the plug with the connector pins.

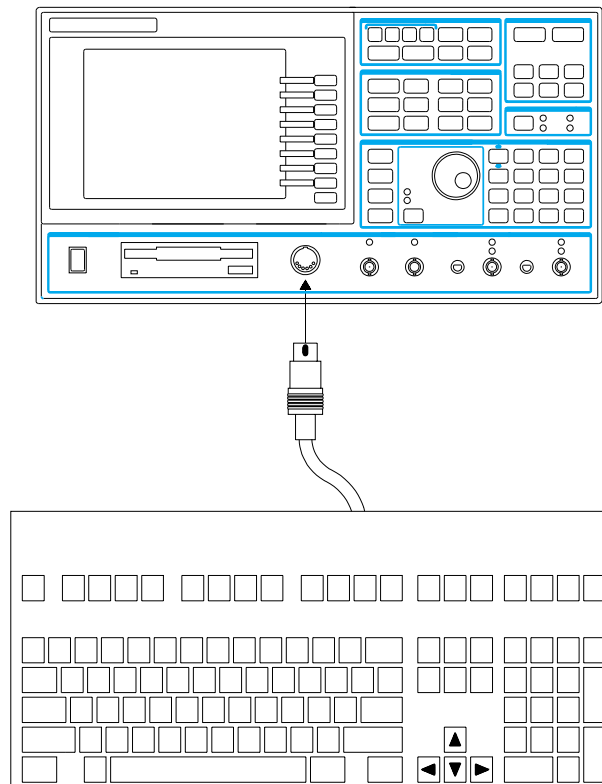

- 3** Connect the other end of the keyboard cable to the keyboard.

Caution

In addition to the U.S. English keyboard, the Agilent 89410A DC-10 MHz Vector Signal Analyzer supports U.K. English, German, French, Italian, Spanish, and Swedish. Use only the Agilent Technologies approved keyboard for this product. Agilent Technologies does not warrant damage or performance loss caused by a non-approved keyboard. See the beginning of this guide for part numbers of approved Agilent Technologies keyboards.

- 4** To configure your analyzer for a keyboard other than U.S. English, press **[System Utility]** [more] [keyboard type]. Then press the appropriate softkey to select the language.

Configuring your analyzer to use a keyboard other than U.S. English only ensures that the analyzer recognizes the proper keys for that particular keyboard. Configuring your analyzer to use another keyboard *does not* localize the on-screen annotation or the analyzer's online HELP facility.

To clean the screen

The analyzer screen is covered with a plastic diffuser screen (this is not removable by the operator). Under normal operating conditions, the only cleaning required will be an occasional dusting. However, if a foreign material adheres itself to the screen, do the following:

- 1 Set the power switch to off (**O**).
- 2 Remove the power cord.
- 3 Dampen a soft, lint-free cloth with a mild detergent mixed in water.
- 4 Carefully wipe the screen.

Caution

Do not apply any water mixture directly to the screen or allow moisture to go behind the front panel. Moisture behind the front panel will severely damage the instrument.

To prevent damage to the screen, do not use cleaning solutions other than the above.

To store the analyzer

- Store the analyzer in a clean, dry, and static free environment. For other requirements, see environmental specifications in the *Agilent 89410A Technical Data* publication in the beginning of your *Installation and Verification Guide*.

To transport the analyzer

- **Package the analyzer using the original factory packaging or packaging identical to the factory packaging.**
Containers and materials identical to those used in factory packaging are available through Agilent Technologies offices.
- **If returning the analyzer to Agilent Technologies for service, attach a tag describing the following:**
 - Type of service required
 - Return address
 - Model number
 - Full serial numberIn any correspondence, refer to the analyzer by model number and full serial number.
- **Mark the container FRAGILE to ensure careful handling.**
- **If necessary to package the analyzer in a container other than original packaging, observe the following (use of other packaging is not recommended):**
 - Wrap the analyzer in heavy paper or anti-static plastic.
 - Protect the front panel with cardboard.
 - Use a double-wall carton made of at least 350-pound test material.
 - Cushion the analyzer to prevent damage.

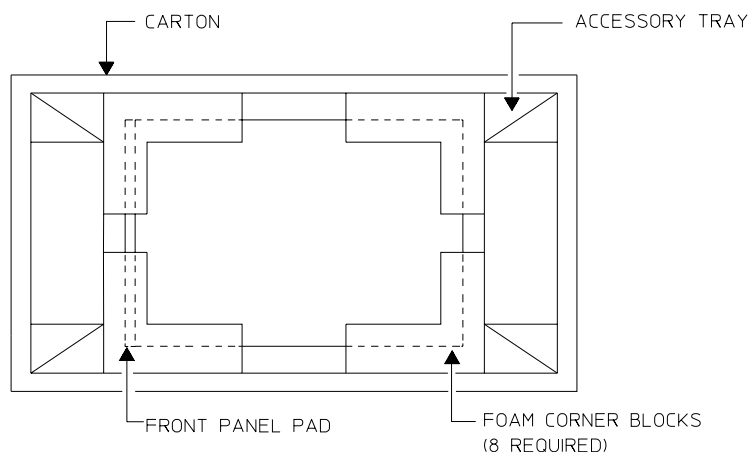

Caution

Do not use styrene pellets in any shape as packing material for the analyzer. The pellets do not adequately cushion the analyzer and do not prevent the analyzer from shifting in the carton. In addition, the pellets create static electricity which can damage electronic components.

If the analyzer will not power up

- Check that the power cord is connected to the Agilent 89410A and to a live power source.
- Check that the front-panel switch is on (I).
- Check that the voltage selector switch is set properly.
See "To change the line-voltage selector switch" on page 7-8.
- Check that the fuse is good.
See "To change the fuse" on page 7-9.
- Check that the analyzer's air circulation is not blocked.
Cooling air enters the analyzer through the rear panel and exhausts through both sides. If the analyzer's air circulation is blocked, the analyzer powers down to prevent damage from excessive temperatures. The analyzer remains off until it cools down and its power switch is set to off (O) then to on (I).
- Obtain service, if necessary. See "Need Assistance?" at the end of this guide.

Index

!

16QAM demodulation, example OP 8-1
2-channels
 digital demod OP 6-12
 video demod OP 7-15
32QAM signal, example OP 9-2

A

A,B,C,D LEDs HT
ac line voltage GS 7-2
adjacent-channel power GS 2-6
air circulation GS 7-7
aliasing
 digital demod OP 17-11
 video demod OP 18-11
alpha entry, using HT
alpha, setting HT
AM demodulation
 algorithm OP 15-9
 example OP 1-2
AM demodulation, using HT
amplitude droop (in symbol table) HT
analyzers
 types of OP 13-4
applications softkey HT
arbitrary softkey HT
arbitrary source, example GS 3-2
arbitrary waveforms
 See source
arm
 See external arm
arrow keys HT
AUI connector GS 7-10, HT
auto cal on/off softkey HT
auto sweep, selecting HT
auto zero calibration
 See calibration
autorange softkeys HT
autorange, using HT

autostate file HT
 creating HT
 recalling HT
averaging HT
 about averaging HT
 auto correlation traces HT
 available averaging functions HT
 cross correlation traces HT
 cross spectrum traces HT
 exponential averaging HT
 fast averaging HT
 frequency response traces HT
 in analog demodulation OP 15-13
 in digital demodulation OP 17-12
 instantaneous-spectrum traces HT
 long averages and calibration HT
 overlap processing HT
 pausing HT
 peak-hold averaging HT
 repeat averaging HT
 rms averaging HT
 rms exponential averaging HT
 selecting an averaging function HT
 selecting the number of averages HT
 single-stepping HT
 spectrum traces HT
 time averaging HT
 time exponential-averaging HT
 video demodulation OP 18-14
 with digital demodulation HT
averaging, fast, example GS 2-2
AYA (vector modulation analysis) HT
AYB (spectrogram/waterfall) HT
 spectrogram displays HT
 waterfall displays HT
AYH (video modulation analysis) HT

B

band power measurements GS 2-3,
GS 2-6, HT

Index

- band-selectable measurements OP 14-3
 - See also* zoom measurements
 - bandwidth
 - See* information bandwidth
 - See* noise equivalent bandwidth
 - See* resolution bandwidth
 - See* window bandwidth
 - bandwidth coupling OP 14-4
 - baseband measurements OP 14-3, HT
 - baseband signals
 - digital demod OP 6-12
 - video demod OP 7-15
 - BASIC HT
 - about HP instrument BASIC HT
 - available utilities HT
 - creating a program with keystrokes HT
 - debugging a program HT
 - deleting a function HT
 - deleting a program HT
 - deleting a subprogram HT
 - deleting multiple functions HT
 - deleting multiple subprograms HT
 - displaying a program HT
 - displaying graphics HT
 - editing a program HT
 - executing a single program line HT
 - indenting nested programs HT
 - memory allocations HT
 - printing a program HT
 - program error messages HT
 - program variables HT
 - re-saving programs HT
 - recalling programs HT
 - renumbering a program HT
 - resetting a program HT
 - running a program HT
 - saving programs HT
 - securing a program HT
 - specifying columns HT
 - stack space, auto allocation HT
 - stack space, manual allocation HT
 - stopping a program HT
 - beeper on/off softkey HT
 - bins
 - See* frequency points
 - bins, defined HT
 - bit patterns, digital demodulation
 - See* symbol states
 - block diagrams HT
 - analog demodulation OP 15-3, HT
 - arbitrary source HT
 - ch1 + j*ch2 receiver HT
 - connectors, front panel HT
 - connectors, rear panel HT
 - digital demodulation OP 17-3, HT
 - FFT overview HT
 - general OP 13-11
 - HP IBASIC memory HT
 - instantaneous spectrums HT
 - main memory HT
 - measurement data HT
 - measurement memory HT
 - scalar OP 12-3, HT
 - source block diagram HT
 - time capture HT
 - traces HT
 - vector OP 12-5, HT
 - video demodulation OP 18-3
 - block size
 - See* time record size
 - BPSK/8PSK softkey HT
 - BT, setting HT
 - burst modulation
 - See* demodulation, digital
- ## C
- C/N (carrier-to-noise) HT
 - C/No (carrier-to-noise-density) HT
 - CAL?, definition of HT
 - calibration HT
 - about calibration HT
 - adjusting calibration data HT
 - analog demodulation, calibrating HT
 - auto zero calibration HT
 - auto zero calibration, single HT
 - performing a single calibration HT
 - saving calibration data HT
 - time-domain calibration HT
 - capture
 - See* time capture
 - carrier frequency error (in symbol table) HT
 - carrier locking
 - analog demod OP 15-8
 - video demod OP 17-8, OP 18-8
 - carrier offset (FSK) HT
 - carrier to noise markers GS 2-4
 - carrier, auto OP 15-8

- center frequency HT
 - setting center frequency HT
 - setting with the marker HT
 - signal tracking HT
 - centronics port GS 7-11
 - ch1 + j*ch2 receiver HT
 - changing numeric parameters HT
 - channel 1, channel 2
 - See* input channels
 - channel 1 and 2 connectors HT
 - circulation, air GS 7-7
 - cleaning the screen GS 7-16
 - clear source trip softkey HT
 - coherence GS 5-8, HT
 - color index softkey HT
 - color, adjusting HT
 - connector
 - AUI GS 7-10
 - external monitor GS 7-12
 - external reference GS 7-12
 - grounding requirements GS 7-3
 - HP-IB GS 7-11
 - keyboard GS 7-14
 - oven reference GS 7-13
 - parallel GS 7-11
 - serial GS 7-10
 - system interconnect GS 7-11
 - ThinLAN GS 7-10
 - connector, front panel connectors HT
 - connectors, rear panel connectors HT
 - constellation diagram
 - example OP 6-5, OP 7-12
 - using HT
 - continuing a measurement HT
 - continuous sweep, selecting HT
 - cooling GS 7-7
 - coordinates, trace
 - See* traces
 - copying files between 3.5 inch diskettes HT
 - cords, power GS 7-3
 - correlation HT
 - auto correlation HT
 - cross correlation softkey HT
 - cross-correlation, math function HT
 - coupling
 - bandwidth OP 14-4
 - cross spectrum measurements HT
 - CW (fixed sine) softkey HT
- D**
- data comment header HT
 - data format hardkey HT
 - data registers HT
 - about data registers HT
 - displaying data-register contents HT
 - removing HT
 - DATA?, definition of HT
 - date, changing HT
 - dc measurements OP 14-9
 - dc offset softkey HT
 - dc response OP 14-9
 - decibels HT
 - DECT (digital european cellular telephone) HT
 - demodulation, analog HT
 - carrier locking OP 15-8
 - about analog demodulation HT
 - affects on bandwidth HT
 - AM demodulation HT
 - auto carrier HT
 - averaging OP 15-13
 - block diagram OP 15-3, HT
 - carrier frequency, displaying HT
 - FM demodulation HT
 - gating OP 15-13, OP 16-5
 - making zero span measurements HT
 - overview OP 12-6
 - PM demodulation HT
 - triggering OP 15-13, HT
 - two channel measurements HT
 - See also* AM, FM, PM demodulation
 - demodulation, digital HT
 - about digital demodulation HT
 - aliasing, IQ measured spectrum HT
 - amplitude droop (in symbol table) HT
 - averaging HT
 - block diagrams OP 17-3, HT
 - BPSK/8PSK HT
 - carrier frequency error (in symbol table) HT
 - carrier locking HT
 - connections HT
 - constellation diagram HT
 - constellation points, viewing OP 8-5
 - DQPSK HT
 - error-vector magnitude (in symbol table) HT

Index

- demodulation, digital (continued)
 - error-vector magnitude trace HT
 - example OP 8-1
 - eye diagram HT
 - filtering OP 17-16, HT
 - filters, user defined OP 9-6
 - formatting displays OP 17-7
 - I/Q measured, displaying HT
 - I/Q origin offset (in symbol table) HT
 - I/Q reference, displaying HT
 - ideal states HT
 - magnitude error HT
 - magnitude error, FSK HT
 - magnitude-error trace HT
 - maximum time points, setting HT
 - memory allocation HT
 - MSK (minimum shift keying) HT
 - normalization HT
 - phase error (in symbol table) HT
 - phase-error trace HT
 - points-per-symbol, setting HT
 - power calculation OP 8-4
 - pulse modulation HT
 - pulse search OP 6-6
 - QAM HT
 - QPSK (quadrature psk) HT
 - setting up HT
 - setup OP 6-2, OP 17-6
 - signal creation OP 9-2
 - SNR HT
 - span, for spectrum displays HT
 - standard setups, example OP 6-4, HT
 - state definitions, defining HT
 - state definitions, displaying HT
 - symbol clock, adjusting HT
 - symbol rate, setting HT
 - symbol table HT
 - sync offset, setting HT
 - sync pattern, setting HT
 - sync patterns, pre-defined HT
 - sync search OP 6-8
 - sync words, using HT
 - tips for using digital demodulation HT
 - trellis diagram HT
 - troubleshooting HT
 - See also* FSK
- demodulation, video HT
 - about video demodulation HT
 - block diagram OP 18-3
 - capabilities OP 18-2
 - carrier frequency error (in symbol table) HT
 - carrier locking OP 17-8, OP 18-8, HT
 - center frequency, setting OP 7-4
 - constellation diagram HT
 - constellation points, viewing OP 8-5
 - DVB QAM 16/32/64 HT
 - DVB QAM state definitions HT
 - DVB QAM, example OP 7-10
 - error-vector magnitude (in symbol table) HT
 - example OP 8-1
 - eye diagram HT
 - filtering HT
 - filters, user defined OP 9-6
 - formatting and displaying OP 18-7
 - formatting displays OP 7-12
 - hexadecimal, in symbol table HT
 - I/Q measured, displaying HT
 - I/Q origin offset (in symbol table) HT
 - ideal states HT
 - magnitude error HT
 - maximum time points, setting HT
 - mirrored spectrums OP 18-17, HT
 - normalization HT
 - phase error (in symbol table) HT
 - points-per-symbol, setting HT
 - QAM 16/32/64/256 HT
 - range, setting OP 18-10
 - setup OP 7-2
 - setup, 32 DVB QAM OP 7-8
 - signal creation OP 9-2
 - SNR HT
 - state definitions, defining HT
 - state definitions, displaying HT
 - symbol clock, adjusting HT
 - symbol locking OP 17-8, OP 18-8
 - symbol rate, setting HT
 - sync patterns, pre-defined HT
 - sync search OP 7-13
 - trellis diagram HT
 - troubleshooting HT
 - VSB 8/16 HT
 - VSB, example OP 7-6

- detection OP 14-12, HT
 - about detection HT
 - normal detector HT
 - positive peak detector HT
 - sample detector HT
- deviation (FSK) HT
- diagnostics softkey HT
- digital demodulation
 - See* demodulation, digital
- disk drive
 - setting up GS 6-2
- disk drives HT
 - about disk drives HT
 - comparison HT
 - copying files HT
 - deleting files HT
 - displaying contents of HT
 - external disk drive HT
 - formatting HT
 - HP-IB address: external disk drive HT
 - internal disk drive HT
 - non-volatile RAM disk HT
 - packing a disk HT
 - renaming files HT
 - selecting a default disk HT
 - using disk specifiers HT
 - volatile RAM disk HT
 - volatile RAM disk, removing HT
- display HT
 - adjusting the color HT
 - allocating portion for programs HT
 - blanking HT
 - changing colors HT
 - cleaning GS 7-16
 - connecting external GS 7-12
 - indicators HT
 - See also* traces
- display group hardkeys HT
- display points, defined HT
- display resolution OP 14-11, OP 14-12
- display state definitions OP 8-10
- display, digital OP 14-9
- documentation HT
- DQPSK softkey HT
- DVB QAM HT
 - block diagram OP 18-4
- dynamic signal analyzers OP 13-6
- E**
- entry group hardkeys HT
- equivalent noise bandwidth HT
- error & status messages HT
- error analysis
 - digital demod OP 8-12
 - video demod OP 8-12
- error summaries
 - video demod OP 8-8
- error vector, example OP 8-12
- error-vector magnitude (in symbol table) HT
- error-vector magnitude, displaying
 - EVM trace HT
- EXT ARM connector HT
- EXT REF IN connector HT
- EXT REF OUT connector HT
- EXT TRIGGER connector HT
- external
 - frequency reference GS 7-12
 - keyboard GS 7-14
 - monitor GS 7-12
- external arm HT
 - about external arm HT
 - trigger, using with external arm HT
 - turning on/off HT
- external disk
 - See* disk drive
- EXTERNAL MONITOR connector HT
- external receiver
 - See* receiver
- external setup softkey HT
- external softkey HT
- external trigger, overview HT
- eye diagram, example OP 6-5, OP 7-12
- eye diagram, using HT
- F**
- failure, power up GS 7-18
- fault log, displaying HT
- FFT OP 13-6
 - properties of OP 13-7
 - See also* spectrum analyzers
- FFT, overview & terminology HT
- FILLING TIME RECORD HT
- filters
 - digital demodulation OP 17-16, HT
 - gaussian OP 17-18
 - IF OP 14-18
 - raised cosine OP 17-17
 - square-root raised cosine OP 17-17
 - user defined OP 9-6
 - user defined OP 17-18
 - video OP 14-3

Index

- firmware version, displaying HT
 - FM demodulation
 - algorithm OP 15-12
 - example OP 1-7, OP 3-4
 - FM demodulation, using HT
 - fonts HT
 - formatting a disk GS 6-6
 - fourier transform OP 13-7
 - French softkey HT
 - freq counter softkey HT
 - frequency HT
 - about frequency parameters HT
 - center frequency HT
 - external reference GS 7-12
 - frequency counter HT
 - frequency span HT
 - manual frequency, setting HT
 - optional oven reference GS 7-13
 - signal tracking HT
 - span, extending to 8 mhz HT
 - start frequency HT
 - step size HT
 - stop frequency HT
 - using markers to set step size HT
 - frequency domain overview OP 13-2
 - frequency error (in symbol table) HT
 - frequency points OP 14-5, HT
 - about frequency points HT
 - and display OP 14-12
 - memory allocation HT
 - setting the number of HT
 - frequency resolution OP 14-11
 - frequency response measurements HT
 - frequency response, measuring GS 5-1
 - frequency span
 - and display OP 14-5
 - and information bandwidth OP 14-3
 - and resolution bandwidth OP 14-14, OP 14-19
 - video demodulation OP 17-11, OP 18-12
 - front panel tour HT
 - FSK
 - about FSK HT
 - block diagram OP 17-5, HT
 - carrier magnitude-error HT
 - carrier offset (in symbol table) HT
 - deviation (in symbol table) HT
 - FSK error (in symbol table) HT
 - FSK error trace, displaying HT
 - FSK measured HT
 - FSK (continued)
 - FSK reference HT
 - magnitude error (in symbol table) HT
 - setting the span to symbol rate ratio HT
 - state definitions HT
 - See also* demodulation, digital
 - FTP (File Transfer Protocol) HT
 - FTP, and LAN OP 10-10
 - full span softkey HT
 - fuse GS 7-9
- ## G
- gate length softkey HT
 - gate time-record HT
 - displaying HT
 - gate delay HT
 - gate time HT
 - gate-delay step size HT
 - setting the length of HT
 - turning on/off HT
 - GATHERING DATA, definition of HT
 - gating
 - description OP 16-2
 - example OP 3-3, OP 4-2, GS 3-1
 - in analog demodulation OP 15-13
 - gaussian filters OP 17-18
 - German softkey HT
 - ghosted softkeys HT
 - grids HT
 - 1 grid HT
 - 2 grids HT
 - 4 grids HT
 - hiding HT
 - multiple GS 5-7
 - overlapped GS 5-7
 - grounding requirements GS 7-3
 - group delay softkey HT
 - GSM (Group Service Mobile) HT
 - guardbands, analog demodulation OP 15-7
- ## H
- half LED HT
 - description of HT
 - using to set the range HT
 - hardkeys, defined HT
 - Help hardkey HT
 - help, online GS 1-1
 - hold scale softkey HT
 - horizontal axis
 - See* X-axis
 - HP-GL HT

- HP-IB
 - about the HP-IB HT
 - addressable only HT
 - devices, setting up GS 6-2
 - HP-IB address: analyzer HT
 - HP-IB address: external devices HT
 - HP-IB address: external disk drive HT
 - HP-IB address: external receiver HT
 - HP-IB address: plotter HT
 - HP-IB address: printer HT
 - HP-IB connector GS 7-11
 - HP-IB controllers HT
 - keys that have HP-IB commands HT
 - LAN use OP 10-6
 - system controller HT
- I**
 - I-BASIC, instrument BASIC
 - See* BASIC
 - I/Q information
 - See* demodulation, digital
 - ideal state softkey HT
 - IF bandwidth, external receiver HT
 - IF center frequency, external receiver HT
 - IF section (0-10 mhz) softkey HT
 - IF trigger
 - See* trigger
 - pulse search OP 18-16
 - incoming inspection GS 7-5
 - indent softkey HT
 - indicators, display HT
 - INF, meaning of HT
 - information bandwidth OP 14-3, OP 14-10
 - input channels HT
 - about input channels HT
 - channel 2 with rf section HT
 - clearing input overloads HT
 - compensating for gain & delay HT
 - connections HT
 - coupling: ac or dc HT
 - dBm calculations HT
 - disabling HT
 - disabling the anti-alias filter HT
 - input impedance HT
 - input-state table HT
 - input hardkey HT
 - input section (ch1 + j*ch2) softkey HT
 - input state GS 6-9
 - installation GS 7-7
 - installing options HT
 - instantaneous spectrum HT
 - instrument mode hardkey HT
 - interface
 - HP-IB GS 7-11
 - LAN GS 7-10
 - parallel GS 7-11
 - serial GS 7-10
 - IQ measured signal OP 17-9, OP 18-10
 - IQ reference signal OP 17-9, OP 18-10
 - Italian softkey HT
- K**
 - keyboard HT
 - about the keyboard HT
 - connecting GS 7-14
 - keyboard connector HT
 - keyboard type HT
 - knob HT
 - about the knob HT
 - changing the operation of HT
- L**
 - LAN GS 7-10
 - about advanced LAN (option UG7) HT
 - about the lan HT
 - activating OP 10-5
 - addressing OP 10-4
 - and FTP OP 10-10
 - connectors, descriptions HT
 - controlling the analyzer via the lan HT
 - ethernet address, displaying HT
 - FTP (File Transfer Protocol), using HT
 - gateway address, setting HT
 - HP-IB with OP 10-6
 - interface, connecting OP 10-1
 - IP address, setting HT
 - port, configuring HT
 - ports, activating HT
 - ports, selecting HT
 - subnet mask, setting HT
 - Telnet, about HT
 - X-Windows with OP 10-7
 - X11 display, configuring HT
 - X11 display, control HT
 - X11 display, setting the update rate HT
 - X11 IP address, setting HT
 - LAN (local area network) HT
 - leakage OP 14-6
 - learning products (manuals) HT
 - LEDs: front panel HT
 - level softkey HT

Index

- line voltage
 - required GS 7-2
 - selector switch GS 7-8
 - linear averaging
 - See* time averaging
 - lines
 - See* frequency points
 - lines, defined HT
 - listen LED HT
 - LO feedthrough
 - See* zero response
 - loading files
 - See* recalling
 - Local Area Network
 - See* LAN
 - local oscillator OP 13-12
- M**
- magnitude error
 - See* demodulation, digital
 - magnitude log(dB)/linear softkey HT
 - main length softkey HT
 - main time vs. gate time HT
 - main time-record
 - displaying HT
 - length equal to gate length HT
 - main length HT
 - main time HT
 - setting the length of HT
 - See also* time record
 - manual sweep OP 14-13
 - manual sweep, selecting HT
 - manuals, for this product HT
 - Marker Cnt, meaning of HT
 - marker group hardkeys HT
 - Marker Man, meaning of HT
 - marker readout HT
 - Marker/Entry LED HT
 - markers HT
 - about markers HT
 - absolute GS 5-4
 - band power GS 2-3, GS 2-6, HT
 - band power, rms square-root of HT
 - carrier to noise GS 2-4
 - carrier-to-noise HT
 - carrier-to-noise-density HT
 - coupled, example GS 4-3
 - frequency counter HT
 - marker into center frequency HT
 - marker into reference level HT
 - marker into span HT
 - markers (continued)
 - marker into start frequency HT
 - marker into stop frequency HT
 - multiple traces HT
 - offset GS 5-5
 - offset marker, zeroing HT
 - offset markers, repositioning HT
 - offset markers, using HT
 - peak tracking HT
 - polar display markers HT
 - power ratio GS 2-4
 - relative GS 5-5
 - repositioning markers HT
 - search GS 5-6
 - search functions HT
 - trace annotation HT
 - turning on markers HT
 - using for numeric entry HT
 - using to set frequency step size HT
 - using to update frequency values HT
 - waterfall & spectrogram displays HT
 - X-axis, example OP 8-7
 - x-axis, scaling with markers HT
 - markers, polar
 - See* polar markers
 - math HT
 - about math HT
 - cross-correlation math function HT
 - defining a math constant HT
 - displaying math functions HT
 - displaying results HT
 - math constants, overview HT
 - math function operands HT
 - math functions HT
 - memory for math-buffers HT
 - recalling math functions HT
 - saving math functions HT
 - user defined GS 6-7
 - using waterfall/spectrogram HT
 - MAU connector HT
 - measured filter, selecting HT
 - measured signal
 - digital demod OP 17-9
 - video demod OP 18-10
 - measurement calculations,
 - disabling HT
 - measurement data, about HT
 - MEASUREMENT Group hardkeys HT
 - measurement points, defined HT
 - measurement resolution OP 14-11
 - measurement speed, enhancing HT

measurement state GS 6-9, HT
 recalling HT
 saving HT
 measurement time OP 14-2, OP 14-10,
 OP 14-17
 measurements HT
 continuing HT
 displaying the measurement-state
 table HT
 pausing HT
 single-stepping HT
 starting HT
 memory HT
 about memory HT
 capture RAM HT
 erasing HT
 for applications HT
 for frequency points HT
 for temporary math buffers HT
 memory limitations OP 14-19
 menu HT
 mirror freq on/off softkey HT
 mirrored spectrums OP 18-17
 Mkr Val HT
 monitor
 connecting external GS 7-12
 MSK softkey HT

N

NADC (North American Digital
 Cellular) HT
 NADC demodulation, example OP 6-4
 NAN, meaning of HT
 narrowband measurements OP 13-8
 network measurements GS 5-1
 Network, Local Area
See LAN
 NO DATA, definition of HT
 noise equivalent bandwidth OP 14-18
 noise, measuring OP 4-1, GS 2-1
 non-volatile RAM disk
See disk drives
 normalization OP 8-4, HT
 numeric entry softkeys HT

O

offset
 video demod OP 7-13
 offset marker
See markers
 offset, in digital demod OP 6-8

online help GS 1-1
See Help hardkey
 options, installing HT
 options, temporary HT
 origin offset
See demodulation, digital
 output filter on/off softkey HT
 output z softkey (source) HT
 OV1 or OV2, definition of HT
 oven frequency reference GS 7-13
 OVEN REF OUT connector HT
 over LED HT
 description of HT
 using to set the range HT
 overlap processing HT

P

packing a disk HT
 parallel devices, setting up GS 6-2
 parallel port GS 7-11, HT
 pausing a measurement HT
 PCL (HP-GL) HT
 PCL (printer control language) HT
 PDC (Personal Digital Cellular) HT
 peak search HT
 peak track softkey HT
 peak tracking, example OP 3-3
 peak-hold averaging
See averaging
 performance test softkey HT
 periodic chirp softkey HT
 phase GS 5-7
 displayed GS 4-2
 relative, example GS 4-1
 wrap GS 5-7
 phase error
See demodulation, digital
 phase noise, analysis example OP 2-1
 phase, displaying HT
 PHS (PHP) (personal handiphone
 system) HT
 plotter
 setting up GS 6-2
 plotter interface GS 7-10
 plotting GS 6-3, HT
 aborting HT
 about plotting HT
 changing plotter pen assignments HT
 data and file formats HT
 date and time HT
 default pen assignments HT

Index

- plotting (continued)
 - output to file HT
 - plot speed HT
 - selecting an output device HT
 - selecting display items HT
 - setting P1/P2 HT
 - setting the HP-IB address HT
 - specifying line types HT
 - starting HT
 - PM demodulation
 - algorithm OP 15-10
 - example OP 1-5, OP 2-3
 - PM demodulation, using HT
 - points
 - See* frequency points
 - points, defined HT
 - points-per-symbol, setting OP 8-4, HT
 - polar display, using HT
 - polar markers
 - example OP 8-4
 - units, example OP 8-4
 - post-trigger delay HT
 - power HT
 - adjacent-channel GS 2-6
 - band power GS 2-4, GS 2-6, HT
 - band power, rms square-root of HT
 - carrier-to-noise GS 2-4, HT
 - carrier-to-noise density GS 2-5
 - carrier-to-noise-density HT
 - consumption GS 7-2
 - cords GS 7-3
 - power ratio GS 2-4, GS 2-5, GS 2-6, HT
 - turn on failure GS 7-18
 - power calculation, digital
 - demodulation OP 8-4
 - power ratio markers GS 2-4
 - power spectral density GS 2-2
 - pre-trigger delay HT
 - preset hardkey HT
 - printer
 - interface GS 7-10
 - setting up GS 6-2
 - printing GS 6-3, HT
 - aborting HT
 - about printing HT
 - data and file formats HT
 - date and time HT
 - online help, printing HT
 - output to file HT
 - selecting an output device HT
 - selecting display items HT
 - printing (continued)
 - setting the HP-IB address HT
 - starting HT
 - PROBE POWER connectors HT
 - problems, digital/video demod HT
 - PSD measurements HT
 - PSK (phase shift keying) HT
 - pulse length, in digital demod OP 6-6
 - pulse modulation
 - See* demodulation, digital
 - PULSE NOT FOUND HT
 - pulse search
 - in digital demod OP 17-14
 - setup example OP 6-6
 - Demodulation, video OP 18-16
 - pulsed signals, in digital demod OP 17-14
- ## Q
- QAM
 - block diagram, video demod OP 18-4
 - QAM 16/32 softkey HT
 - QAM 16/32/64/256 softkey HT
 - QAM demodulation, example OP 8-1
 - QPSK softkey HT
- ## R
- raised cosine filters OP 17-17
 - RAM
 - See* memory
 - RAM disk
 - See* disk drives
 - random noise softkey HT
 - range HT
 - autoranging HT
 - example GS 5-3
 - setting optimum range HT
 - single ranging HT
 - tracking the reference level HT
 - range hardkey HT
 - RBW
 - See* resolution bandwidth
 - real-time bandwidth HT
 - rear panel tour HT
 - recalling HT
 - about recalling HT
 - autostate file HT
 - BASIC programs HT
 - capture-buffer contents HT
 - math functions HT
 - measurement state HT
 - recalling data GS 6-5

- recalling (continued)
 - spectrogram displays OP 5-16
 - trace GS 3-2, HT
 - waterfall displays OP 5-16
 - receiver HT
 - about receivers HT
 - HP-IB address: external receiver HT HT
 - using an external receiver HT
 - receiver softkey HT
 - REF, definition of HT
 - reference
 - external frequency GS 7-12
 - oven GS 7-13
 - reference filter, selecting HT
 - reference level
 - See* reference line
 - reference line HT
 - displaying HT
 - examples of HT
 - position of HT
 - setting reference level HT
 - setting with the marker HT
 - tracking the range HT
 - reference signal
 - digital demod OP 17-9
 - video demod OP 18-10
 - references
 - digital demod OP 17-2
 - general OP 13-4
 - Remote LED HT
 - requirements
 - grounding GS 7-3
 - power GS 7-2
 - resolution
 - display OP 14-12
 - frequency OP 14-11
 - measurement OP 14-5
 - resolution bandwidth HT
 - about resolution bandwidth HT
 - and gating OP 16-5
 - coupling to frequency span HT
 - digital demod OP 17-11
 - effect on noise OP 14-2
 - entering arbitrary values HT
 - interaction with other parameters HT
 - scalar limitations OP 14-11
 - setting the resolution bandwidth HT
 - vector limitations OP 14-18
 - video demod OP 18-11
 - See also* bandwidth coupling
 - result length
 - digital demod OP 6-8, OP 17-14
 - video demod OP 7-13
 - result length softkey HT
 - rms averaging
 - See* averaging
 - root raised cosine filters OP 17-17
 - RPG
 - See* knob
 - RS232
 - See* serial port
- S**
- safety
 - See* inside front cover
 - sample frequency
 - See* sample rate
 - sample rate OP 14-14
 - video demodulation OP 17-11, OP 18-12
 - samples, defined HT
 - saving HT
 - about saving HT
 - autostate file HT
 - calibration trace HT
 - capture buffer contents HT
 - math functions HT
 - measurement state HT
 - re-saving BASIC programs HT
 - saving BASIC programs HT
 - saving data GS 6-4
 - traces HT
 - scalar measurements HT
 - about scalar mode HT
 - block diagram HT
 - block diagrams OP 12-3
 - limitations OP 14-11
 - overview OP 12-2
 - scale at markers softkey HT
 - scaling HT
 - auto scaling HT
 - x-axis HT
 - x-axis scaling: linear vs. log HT
 - X-axis, example OP 8-7
 - y-axis scaling HT
 - scan time
 - See* sweep time
 - screen, cleaning GS 7-16
 - search length HT
 - digital demod OP 6-8
 - video demod OP 7-13

Index

- search length, in digital demod
 - OP 17-14
- self test HT
 - long confidence test HT
 - quick confidence test HT
 - self-test log HT
- serial 1/serial 2 connectors HT
- serial devices, setting up GS 6-2
- serial number, displaying HT
- serial number, location HT
- serial port GS 7-10
- serial port, configuring & cabling HT
- serial x setup softkey HT
- shifted functions HT
- shipping GS 7-17
- signal to noise markers GS 2-4
- signal track softkey HT
- signal tracking HT
- sine freq softkey HT
- single measurements, running HT
- single range softkeys HT
- single ranging HT
- single sweep, selecting HT
- SNR, digital/video demodulation HT
- softkeys HT
 - about softkeys HT
 - bracketed softkeys HT
 - softkeys that toggle HT
- source HT
 - about the source HT
 - am modulating the output HT
 - amplitude, setting HT
 - arbitrary waveforms HT
 - arbitrary waveforms, duration HT
 - available source outputs HT
 - connections HT
 - CW (fixed sine) output HT
 - dc offset, setting HT
 - displaying the source-state table HT
 - external signals, input to source HT
 - output filter, disabling HT
 - output impedance & dBm units HT
 - output impedance, setting HT
 - output protection, clearing HT
 - periodic chirp & frequency span HT
 - periodic chirp output HT
 - periodic chirp, duration HT
 - random noise output HT
 - sine frequency, setting HT
 - SOURCE LED HT
 - turning on and off HT
- source hardkey HT
- source type softkey HT
- source, setup example GS 5-3
- span HT
 - arbitrary spans HT
 - cardinal spans HT
 - coupling to main length HT
 - in analog demodulation OP 15-6
 - maximum span HT
 - setting span HT
 - setting with the marker HT
 - video demodulation OP 17-11, OP 18-12
 - See also* frequency span
- span softkey HT
- Spanish softkey HT
- spectral displays OP 5-1
- spectral map
 - See* waterfall
- spectrogram HT
 - about spectrogram displays HT
 - colorbar HT
 - colors, selecting HT
 - colors, setting the number of HT
 - displaying OP 5-1
 - enhancing HT
 - markers, using HT
 - number of traces, setting HT
 - pausing HT
 - printing/plotting, formats HT
 - printing/plotting, overview HT
 - real-time indicator HT
 - recalling HT
 - saving HT
 - threshold, setting HT
 - trace buffers, removing HT
 - trace, selecting HT
 - turning on HT
 - using in math functions HT
- spectrum analyzers
 - comparisons OP 13-9
 - types of OP 13-4
- spectrum measurements HT
- speed, enhancing HT
- square-root raised cosine filters OP 17-17
- SRQ LED HT
- standard setups
 - digital demodulation, example OP 6-4

- start frequency HT
 - setting start frequency HT
 - setting with the marker HT
 - starting a measurement HT
 - state definitions HT
 - See* display state definitions
 - See* input state
 - See* measurement state
 - stop frequency HT
 - setting stop frequency HT
 - setting with the marker HT
 - storage GS 7-16
 - suffix menus HT
 - Swedish softkey HT
 - sweep speed
 - See* sweep time
 - sweep time
 - described OP 14-10
 - See also* measurement time
 - sweep, manual OP 14-13
 - sweeping
 - about sweeping HT
 - auto sweep, selecting HT
 - continuous sweep, selecting HT
 - manual sweep, selecting HT
 - single sweep, selecting HT
 - symbol clock, adjusting HT
 - symbol conventions
 - See* display state definitions
 - symbol rate OP 17-11, OP 18-12
 - symbol rate softkey HT
 - symbol states, example OP 8-8
 - symbol table
 - See* demodulation, digital
 - symbol/error table, example OP 8-8
 - SYNC NOT FOUND HT
 - SYNC NOT FOUND, pulse search HT
 - SYNC OUT connector HT
 - sync pattern
 - digital demodulation OP 6-9
 - video demodulation OP 7-14
 - sync search
 - example OP 6-8, OP 7-13
 - in digital demod OP 17-13
 - video demod OP 18-15
 - See also* demodulation, digital
 - See also* demodulation, video
 - sync word
 - digital demodulation OP 6-8
 - video demodulation OP 7-13
 - SYSTEM Group hardkeys HT
 - system interconnect GS 7-11
 - SYSTEM INTERCONNECT
 - connector HT
- T**
- talk LED HT
 - TDMA
 - See* NADC
 - Telnet, about HT
 - testing
 - See* self test
 - ThinLAN connector GS 7-10, HT
 - TIFF (tag-based file format)) HT
 - time averaging OP 14-15
 - See* averaging
 - time capture HT
 - about time capture HT
 - calibration and time-capture HT
 - displaying capture information HT
 - displaying capture-buffer contents HT
 - playback example OP 2-2
 - recalling capture-buffer contents HT
 - recalling data from disk OP 2-2
 - saving capture-buffer contents HT
 - starting a time capture HT
 - time capture buffer HT
 - time corrections HT
 - time corrections, analog demodulation
 - OP 15-5
 - time data OP 14-15
 - time data softkey HT
 - time domain overview OP 13-2
 - time gating HT
 - about time gating HT
 - displaying gate time-record HT
 - gate delay HT
 - gate length HT
 - selecting a window HT
 - turning on/off HT
 - See also* gating
 - time points, digital & video
 - demodulation HT
 - time record OP 13-7, OP 14-16, HT
 - about the time record HT
 - applying a window HT
 - coupling to span HT
 - displaying gate time-record HT
 - displaying main time-record HT
 - effects of averaging HT
 - effects of demodulation HT
 - effects of span HT

Index

- time record (continued)
 - FILLING TIME RECORD HT
 - gate length HT
 - main length HT
 - real vs. complex data HT
 - time record length
 - and memory OP 14-19
 - defined OP 14-16
 - limitations OP 14-19
 - time resltn softkey HT
 - time softkey (averaging) HT
 - time, changing HT
 - time-domain analysis HT
 - time-domain data, displaying HT
 - traces HT
 - about traces HT
 - activating multiple traces HT
 - adding a title HT
 - adding trace information HT
 - auto correlation HT
 - capture buffer contents HT
 - changing colors HT
 - coherence HT
 - coordinates HT
 - cross correlation HT
 - cross spectrum HT
 - data register contents HT
 - disabling measurement calculations HT
 - displaying group delay HT
 - displaying linear magnitude HT
 - displaying log magnitude HT
 - displaying multiple traces HT
 - frequency response HT
 - hiding HT
 - imaginary part , displaying HT
 - instantaneous spectrum HT
 - marker annotation HT
 - math functions HT
 - modifying trace labels HT
 - multiple GS 5-7
 - multiple active GS 5-7
 - overlaid OP 6-10
 - overlying HT
 - phase, displaying HT
 - PSD HT
 - real part (real data), displaying HT
 - recalling HT
 - saving HT
 - scaling data, overview HT
 - selecting measurement data HT
 - spectrum HT
 - traces (continued)
 - time-domain data HT
 - trace boxes HT
 - See also* display
 - See also* grids
 - transporting GS 7-17
 - trellis diagram, using HT
 - trigger HT
 - about trigger HT
 - analog demodulation OP 15-13, HT
 - available trigger signals HT
 - delay HT
 - EXT TRIGGER LED HT
 - external arm, using with trigger HT
 - external trigger HT
 - free run trigger HT
 - HP-IB trigger HT
 - IF channel trigger HT
 - input channel trigger HT
 - level HT
 - slope HT
 - source trigger HT
 - trigger holdoff HT
 - trigger LED HT
 - trigger line HT
 - trigger type softkey HT
 - troubleshooting, digital demod HT
 - two-channels
 - digital demod OP 6-12
 - video demod OP 7-15
- ## U
- U.K. English softkey HT
 - U.S. English softkey HT
 - UFG (LAN and 4 MB memory option) HT
 - UG7 (advanced LAN option) HT
 - UNCAL, definition of HT
 - units: x-axis HT
 - units: y-axis HT
 - user defined filters OP 17-18
- ## V
- vector averaging
 - See* time averaging
 - vector diagram, example OP 6-5, OP 7-12
 - vector measurements OP 13-8, HT
 - about vector mode HT
 - block diagram HT
 - block diagrams OP 12-5
 - overview OP 12-4

video averaging OP 14-3
 video demodulation
 See demodulation, video
 video filtering OP 14-3
 view state GS 6-9
 volatile RAM disk
 See disk drives
 voltage selector switch GS 7-8
 VSB
 block diagram OP 18-6
 center frequency, setting OP 7-4
 VSB 8/16 softkey HT

W

waterfall HT
 about waterfall displays HT
 baselines, showing HT
 displaying OP 5-1
 elevation HT
 hiding traces HT
 markers, using HT
 number of traces, setting HT
 pausing HT
 printing/plotting, formats HT
 printing/plotting, overview HT
 recalling HT
 saving HT
 setting a threshold HT
 skewing HT
 spacing of traces HT
 trace buffers, removing HT
 trace height HT
 trace, selecting HT
 traces, position and baseline HT
 using in math functions HT
 when you can use them HT
 y-axis scaling HT
 window bandwidth
 defined OP 14-18
 values OP 14-18
 windows HT
 about windows HT
 comparison HT
 equivalent noise bandwidth HT
 example GS 5-3
 window bandwidth HT
 window functions OP 14-6
 window shapefactor HT
 windows for gate time record HT
 windows for main time record HT

X

x-axis scaling
 See scaling
 X-axis, scaling and markers OP 8-7
 x-axis, scaling with markers HT
 X-Windows, LAN use OP 10-7
 X11 display, using
 See LAN

Y

y-axis scaling
 See scaling

Z

zero padding OP 14-20
 zero response OP 14-9
 zero span measurements OP 15-2, HT
 zoom measurements OP 13-8, OP 14-3,
 HT

Agilent 89400-Series Documentation Roadmap

If you are thinking about...	And you want to...	Then read the analyzer's...
Unpacking and installing the analyzer	Install the analyzer, or do operation verification or performance verification tests	<i>Installation and Verification Guide</i>
Getting started	Make your first measurements with your new analyzer	<i>Getting Started Guide</i>
	Review measurement concepts	<i>Operator's Guide</i>
	Learn what each key does	Online Help (press the [Help] key)
Making measurements	Learn how to make typical measurements	<i>Getting Started Guide and Operator's Guide</i>
Creating automated measurements	Learn the Agilent Instrument BASIC interface	<i>Agilent 89400-Series Using Agilent Instrument BASIC</i>
(To receive Agilent Instrument BASIC and Agilent Instrument BASIC manuals, order option 1C2)	Program with Agilent Instrument BASIC	<i>Agilent Instrument BASIC User's Handbook</i>
Remote operation	Learn about the GPIB and SCPI	<i>GPIB Programmer's Guide</i>
	Find specific GPIB commands quickly	<i>Agilent 89400-Series GPIB Commands: Quick Reference</i>
	Find GPIB command details	<i>Agilent 89400-Series GPIB Command Reference</i>
Using analyzer data with a PC application	Transfer analyzer data to or from a PC (Personal Computer) application	<i>Standard Data Format Utilities: User's Guide</i>
	Display analyzer data on a PC, or display PC data on the analyzer	
Servicing the analyzer (To receive service information, order option OB3)	Adjust, troubleshoot, or repair the analyzer	<i>Service Guide</i>

Need Assistance?

If you need assistance, contact your nearest Agilent Technologies Sales and Service Office listed in the Agilent Catalog. You can also find a list of local service representatives on the Web at:

<http://www.agilent.com/services/English/index.html> or contact your nearest regional office listed below.

If you are contacting Agilent Technologies about a problem with your Agilent 89410A Vector Signal Analyzer, please provide the following information:

- Model number: Agilent 89410A
- Serial number:
- Options:
- Date the problem was first encountered:
- Circumstances in which the problem was encountered:
- Can you reproduce the problem?
- What effect does this problem have on you?

You may find the serial number and options from the front panel of your analyzer by executing the following:

Press [**System Utility**], [more], [serial number].

Press [**System Utility**], [options setup].

If you do not have access to the Internet, one of these centers can direct you to your nearest representative:

United States	Test and Measurement Call Center (800) 452-4844 (Toll free in US)
Canada	(905) 206-4725
Europe	(31 20) 547 9900
Japan	Measurement Assistance Center (81) 426 56 7832 (81) 426 56 7840 (FAX)
Latin America	(305) 267 4245 (305) 267 4288 (FAX)
Australia/New Zealand	1 800 629 485 (Australia) 0800 738 378 (New Zealand)
Asia-Pacific	(852) 2599 7777 (FAX) (852) 2506 9285
