



Project Management Tools and Techniques

An Introductory Course in Project management Foundations

Training to capstone faculty by Skill Right Sponsored by Texas Instruments, Inc.

Minor modifications by Nayda Santiago



Break Timer



What Is Project Management?

“Project management is the application of **knowledge, skills, tools, and techniques** to project activities in order to **meet or exceed stakeholder needs and expectations.**”

Source: Project Management Institute



Break Timer



Benefits of Project Management

- ✿ Enables completion of projects in the shortest time possible while balancing cost and quality
- ✿ Enhances staffing flexibility and can help accomplish more work with fewer resources
- ✿ Provides timely information to multiple levels of the organization in consistent formats
- ✿ Enhances decision making based on facts and project information
- ✿ Enhances ability to achieve business objectives and goals



Break Timer



What Is a Project?

“A project is a **temporary endeavor** undertaken to create a **unique product or service.**”

Source: PMI

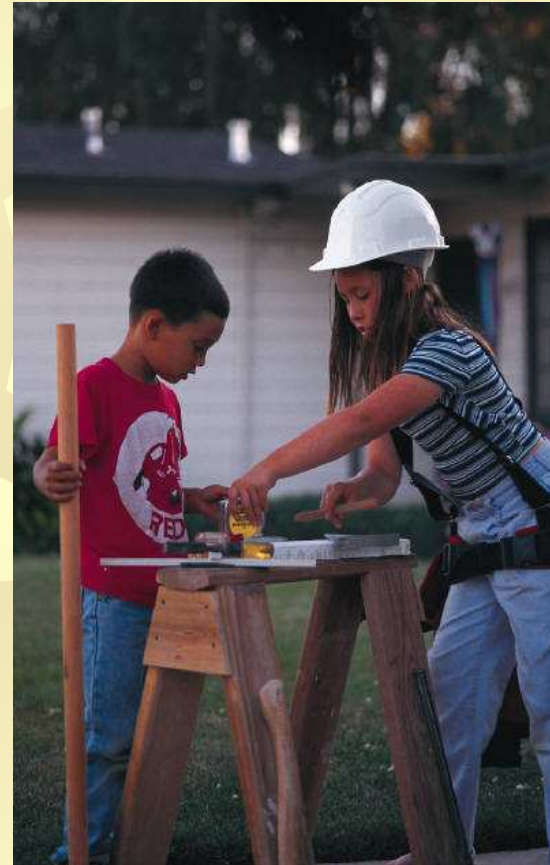

Break Timer



Project Characteristics

- ★ Has a goal/meets a need
- ★ Is a set of related activities that are non-recurring
- ★ Has a definite beginning and end
- ★ Has clearly defined goals and deliverables
- ★ Consumes resources
- ★ Needs to be managed



Break Timer



Project Manager

“The person who is responsible for the project and will be held accountable for its success or failure.”



Break Timer



The Triple Constraint

Project Scope

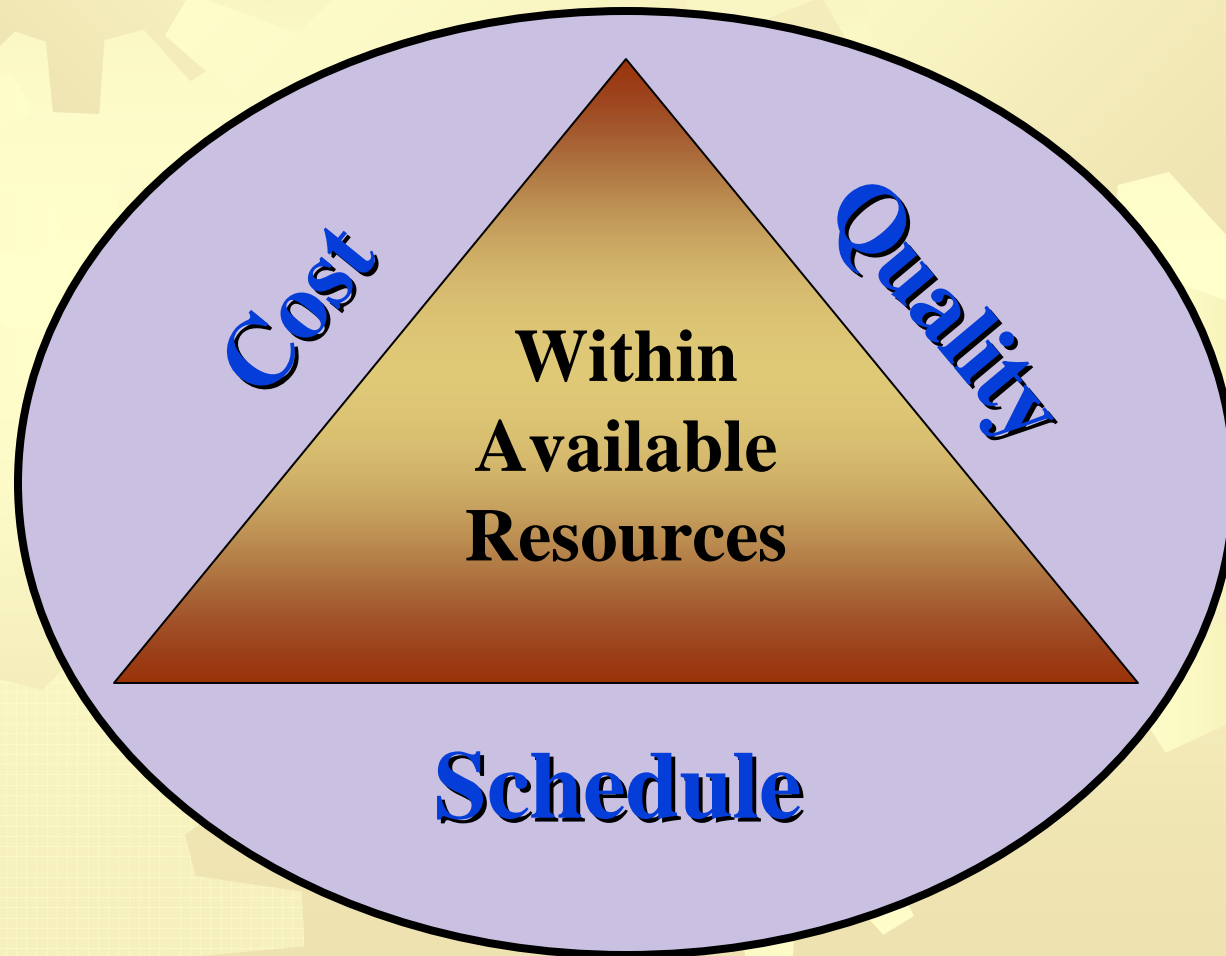

Break Timer



Balancing the “Project Success Triangle”

- ★ A clear understanding of customer priorities
- ★ “People” skills
- ★ Thorough planning
- ★ An organized, structured process



Break Timer

Project Management Process

Source: PMBOK

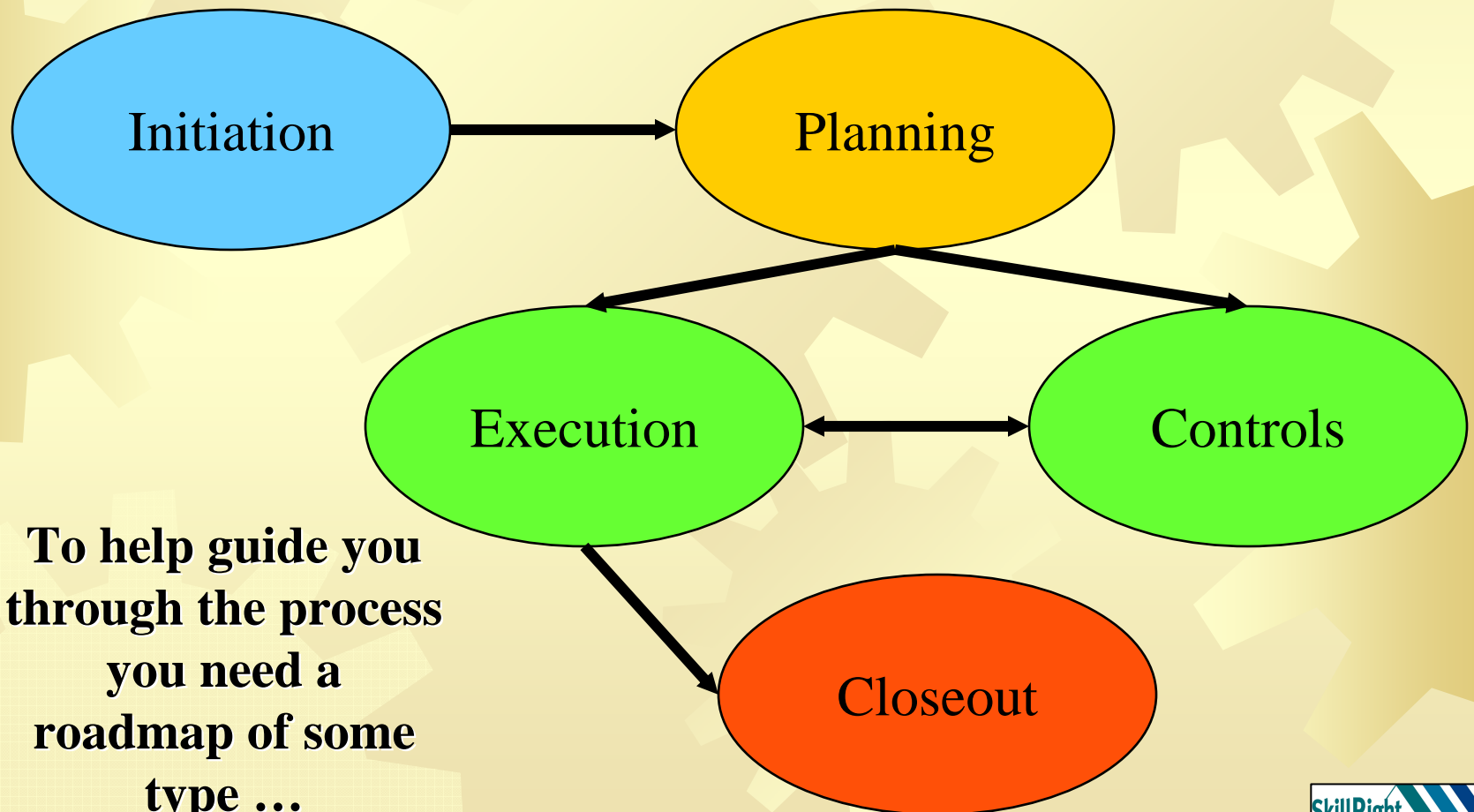

To help guide you through the process you need a roadmap of some type ...



Break Timer



Roadmap to Project Management Success

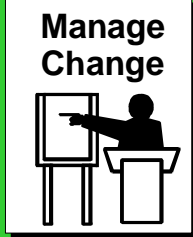
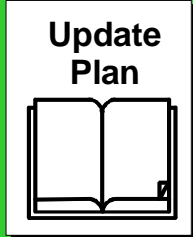
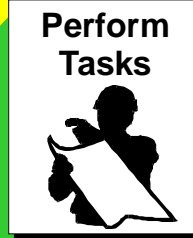
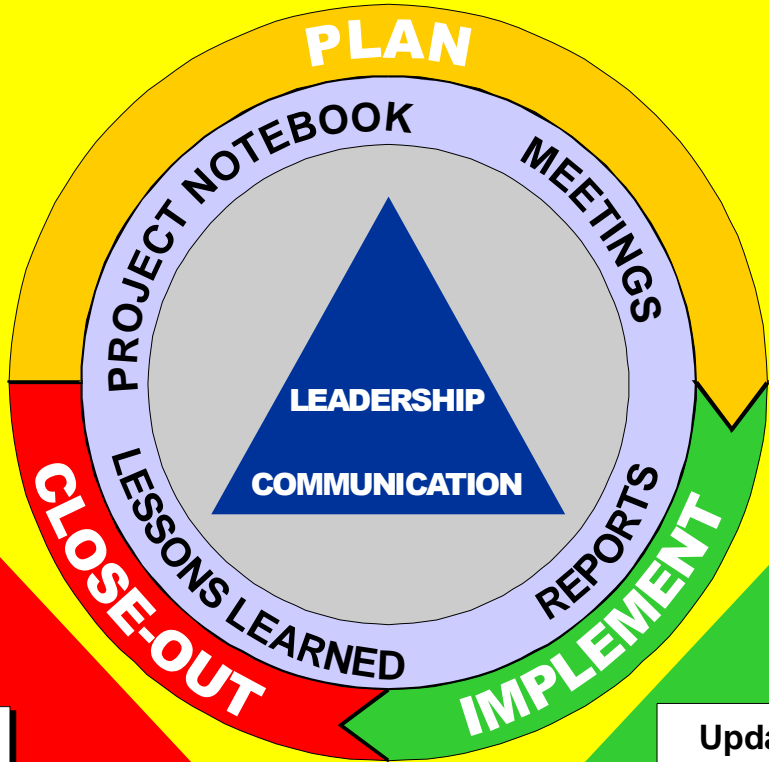
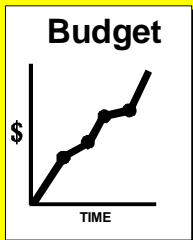
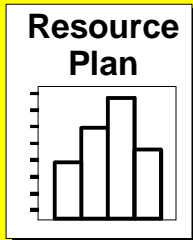
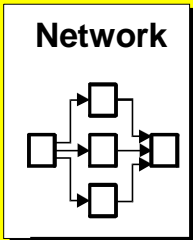
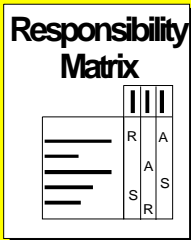
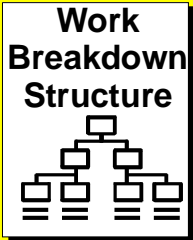
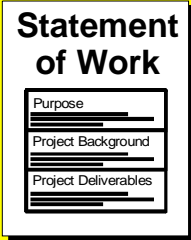

Goals of the Project Management Roadmap

- ★ Meet customer expectations.
- ★ Work within organizational constraints.
- ★ Continuously improve the process.
- ★ Control the cost of **Change**

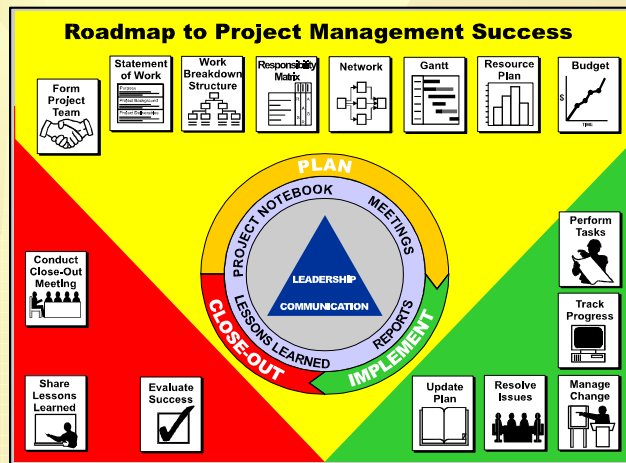

Break Timer

The Cost of Change

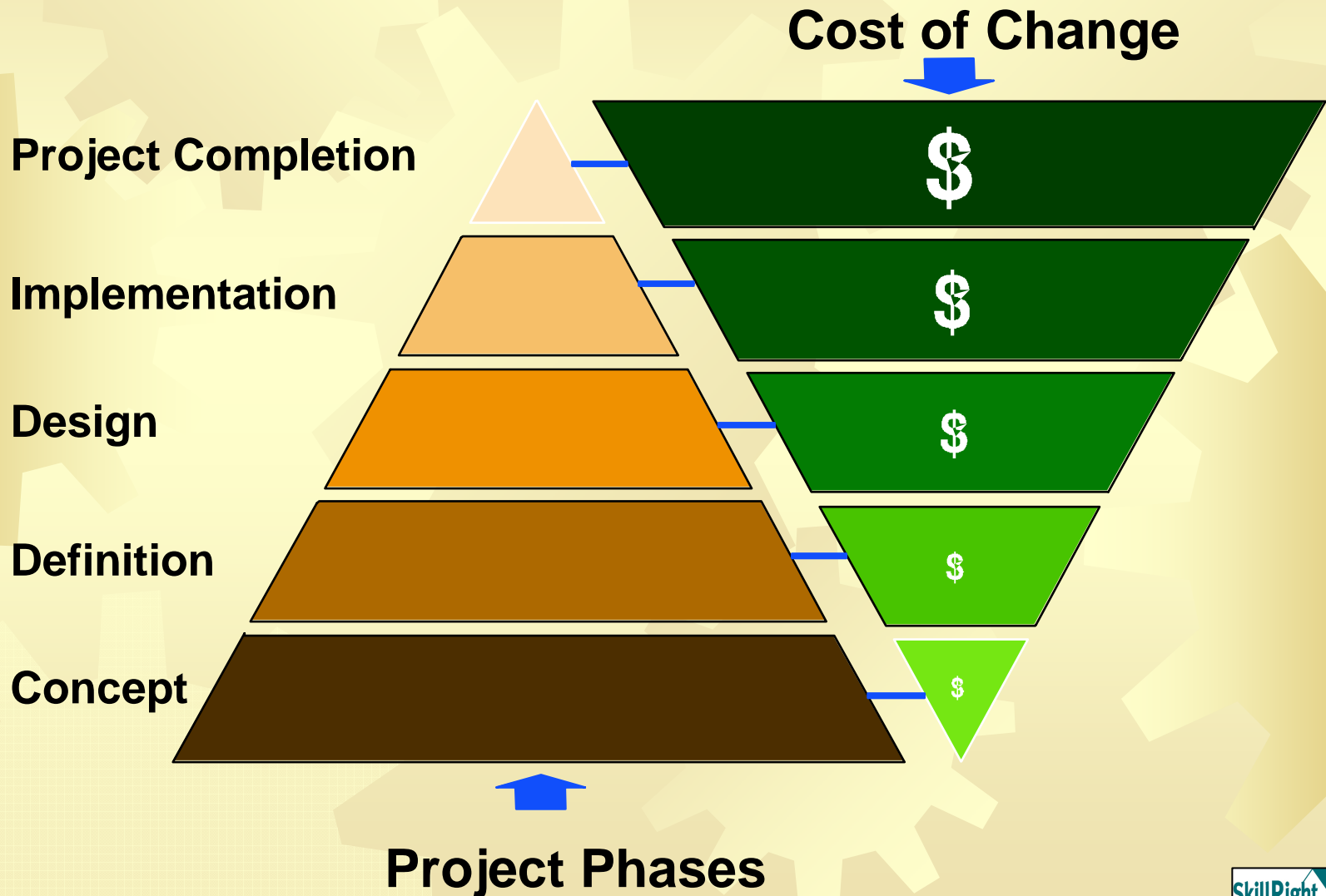

Break Timer

Project Stakeholders

- ✿ What is a project stakeholder?
 - ✿ *If you can gain or lose from the success or failure of a project, you have a “stake” in the project.*



Break Timer

Key Project Stakeholders

- ★ Customer/client
- ★ Project sponsor
- ★ Project manager
- ★ Project team

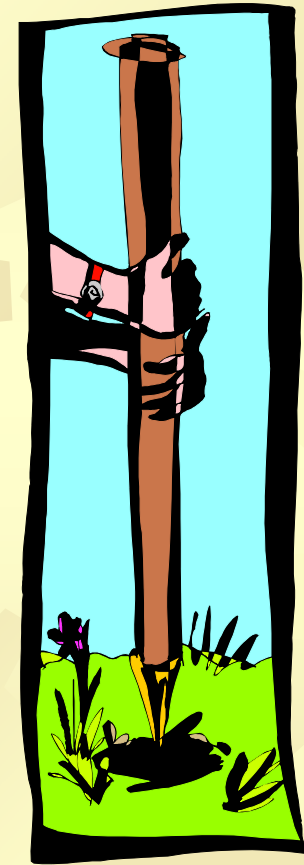

Break Timer

Project Manager

- Define and manage customer expectations.
- Coordinate development of the project plan.
- Monitor and control project work according to the approved plan.
- Communicate project status by preparing status reports and conducting progress review meetings.
- Establish and follow a change management process.
- Lead the project team and resolve conflicts between team members.
- Maintain the project notebook.
- Conducting project close-out activities.



Break Timer

Project Manager Skills

- Leadership
- Communications
- Organizing
- Negotiating
- Managing conflict
- Motivating
- Controlling
- Team building
- Planning
- Directing
- Problem solving
- Coaching
- Delegating
- Supporting

The skill set for a good general manager!!



Break Timer



Project Team Members

- Identify work tasks
- Estimate the duration of work tasks
- Help prepare the project network diagram
- Honestly report work status
- Keep the project manager informed on project issues
- Attend scheduled progress review meetings
- Raise issues important to the project's success
- Keep their functional managers updated
- Participate in the project close-out



Break Timer

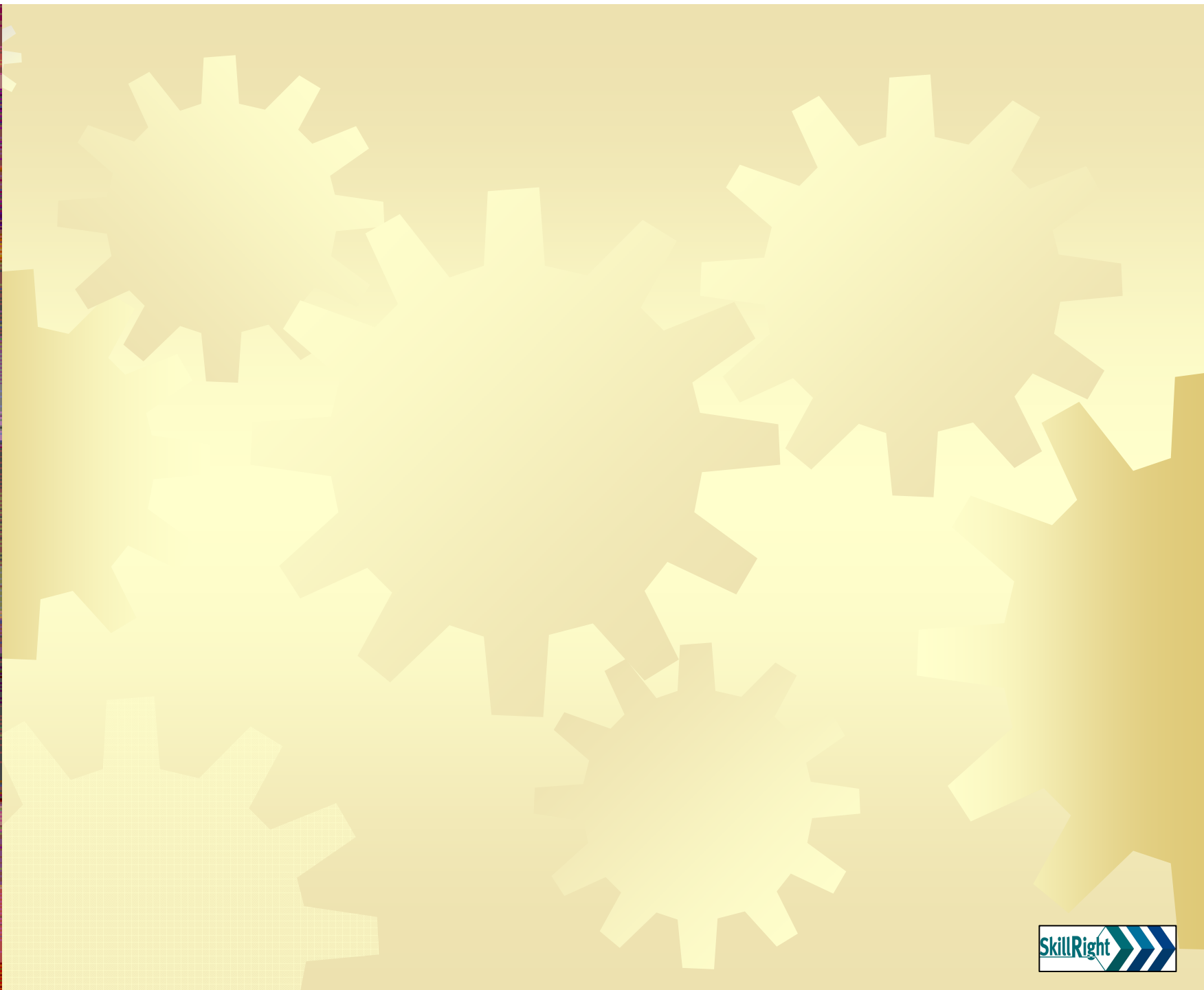

Break Timer



The Project Team

How are project teams formed?

Careful selection process?

Luck of the draw?



Team selection and the strength of the team depends on the company's type of Project Organization!



Break Timer



Organizational Breakdown Structure (OBS)

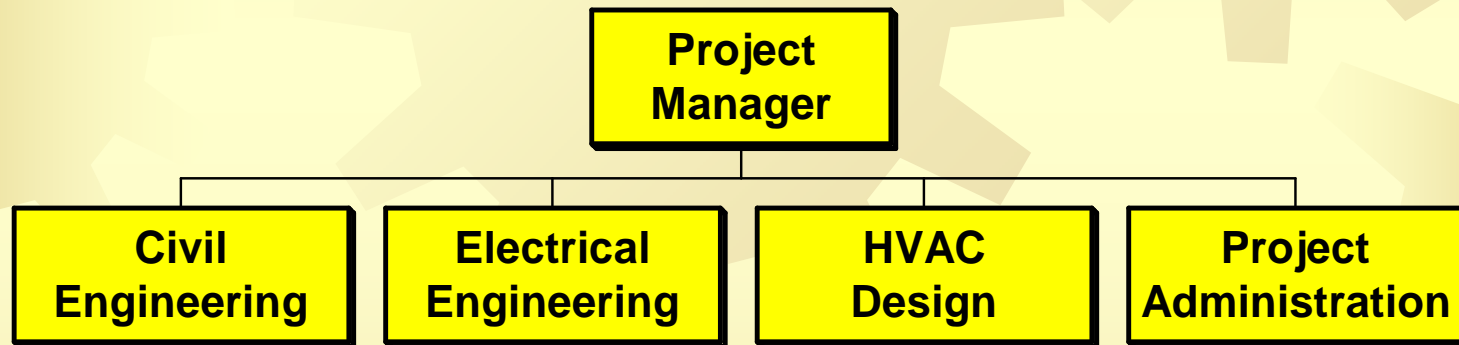

Break Timer



Roadmap to Project Management Success

Form Project Team



Statement of Work

Purpose
Project Back
Project Deliv

Work Breakdown Structure

Responsibility Matrix

	R	A	
S			
			S

Network

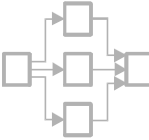

Gantt



Resource Plan

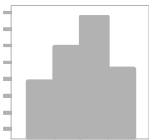

Budget

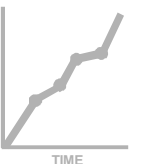

Statement of Work

Purpose
Project Background
Project Deliverables

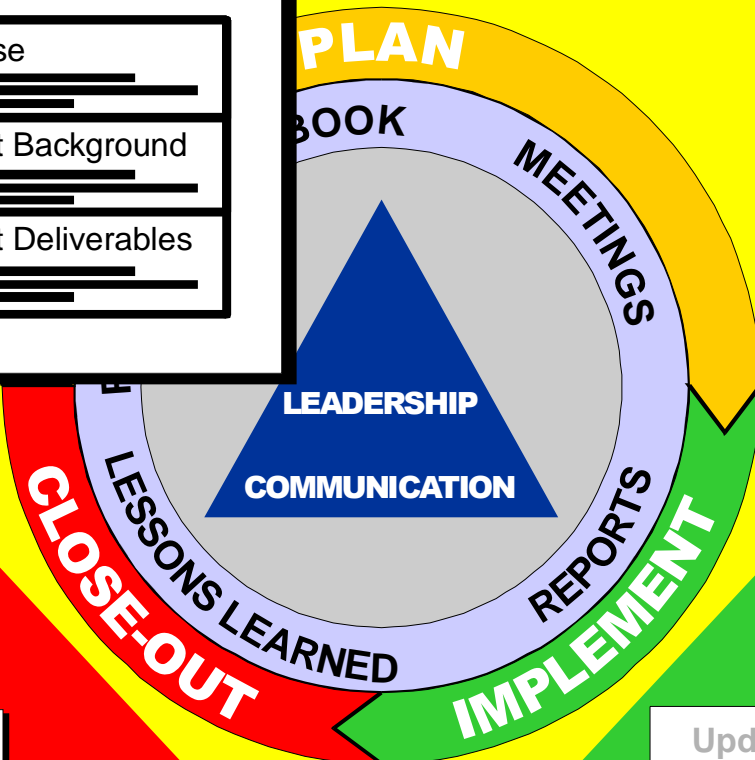

Conduct Close-Out Meeting



Perform Tasks



Track Progress



Share Lessons Learned



Evaluate Success



Update Plan



Resolve Issues



Manage Change



Why Plan?

“The nicest thing about not planning is that failure comes as a complete surprise and is not preceded by a period of worry and depression.”

John Preston, Boston College



Break Timer



Project Plan Contents

- Statement of work (SOW)
- Work breakdown structures (WBS)
- Responsibility assignment matrices
- Project schedule
- Resource plans/histograms
- Budget
- Risk management plan
- Communications plan
- Quality plan
- Verification and validation plan

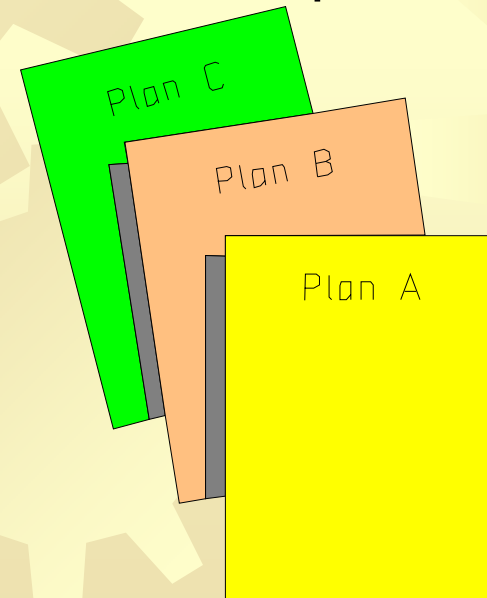

Break Timer

Project Plan Benefits

- ✿ Provides an effective communication tool to ensure understanding of project goals and the means to achieve them
- ✿ Defines outcomes and commitments
- ✿ Establishes guidelines and standards
- ✿ Establishes the baseline for evaluating and reporting progress
- ✿ Forms the basis for scope control and change management



Project Notebook

☀ Project Pre-plan

- Background information
- Customer data
- Third-party data (vendors, suppliers, etc.)

☀ Project Plan

- Statement of Work (SOW)
- Work Breakdown Structure (WBS)
- Organization/responsibility charts
- Schedule data
- Budget/capital plan
- Risk management

☀ Project Implementation

- Meetings (agenda/minutes)
- Team/management/customer/third party progress reports
- Customer change requests/decision matrix issue resolution forms/reports

☀ Project Close-out

- Final evaluation of measurable success indicators
- Close-out meeting (agenda/minutes)
- Final project report
- Reference letters
- Lessons learned

☀ Project Administration

- Contractual documents
- Invoices
- Expenses
- Correspondence
- Contact log



Statement of Work — Purpose

- ✿ Define the scope of the project
- ✿ Establish customer expectations
- ✿ Serve as a “contract” if necessary



Break Timer



A Good SOW will answer ...

- ★ What is the purpose or goal of the project?
- ★ Why is the project being done?
- ★ Who is the initial customer?
- ★ Who is the end user or final customer?
- ★ What are the customer deliverables?
- ★ What technical support is required for the deliverables?



Break Timer



And continue to answer ...

- ★ What is the budget?
- ★ What is the final date for the deliverables?
- ★ What are the measurable success indicators (metrics)?
- ★ What kind of support is required from the customer?
- ★ What contingency plans are in place?



Break Timer



SOW — Generic Contents

- ★ Customer
- ★ Project
- ★ Title
- ★ Purpose
- ★ Background
- ★ Deliverables
- ★ Measurable success indicators
- ★ Customer support
- ★ Risk plans

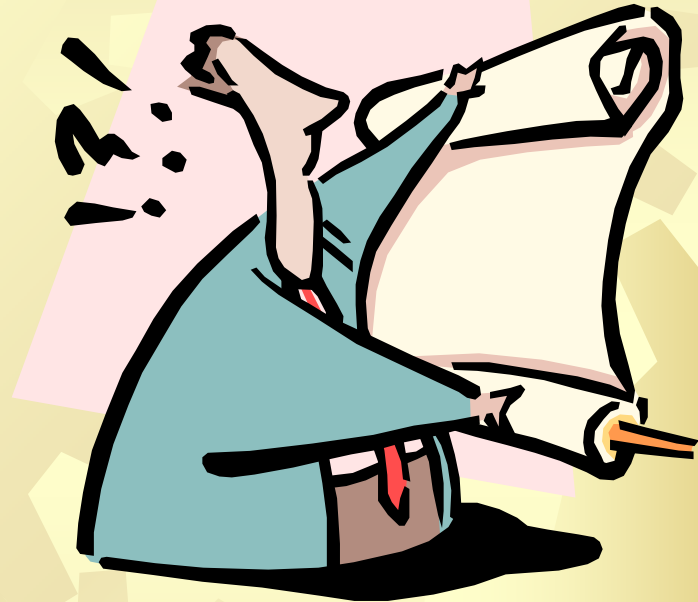

Break Timer

Statement of Work - Page 1

STATEMENT OF WORK

Date: Form completion date
Contributors: People who helped write the statement of work
Immediate Customer: Person or organization requesting the work
Final End User: Person or organization who will use the results of the project

PROJECT TITLE:

The project title should be a short, concise statement that defines the project.

PURPOSE:

The purpose of the project is the goal; why you are doing the project. This should be clearly stated.



Break Timer



PROJECT BACKGROUND:

The project background should contain information pertaining to the history of the project. It also includes a statement that justifies the project.

- ◆ For a first draft, brief statements are acceptable. Formal statements of work are usually in paragraph form.
- ◆ Supply information that explains the philosophy behind the project. Also describe what makes the project unique/special.
- ◆ This information can be used later to:
 - Leverage resources
 - Gain support from external organizations/departments
 - Accommodate management directives
 - Accommodate changes

Many of the statements made in the background section must be substantiated in the measurable success indicators section of the statement of work.

The project background includes the following key elements:

- ◆ History
- ◆ Justification
- ◆ Consequences
- ◆ Uniqueness of project

Some examples on the type of information to include in the project background section include:

- ◆ Meet safety requirements
- ◆ Support business plan
- ◆ Meet quality requirements
- ◆ Meet customer expectations
- ◆ Improve performance/efficiency



DELIVERABLES:

Deliverables are the outputs of the project. They are what is promised to the customer.

- ◆ Deliverables are written as nouns. They are things.
- ◆ Quantities must be identified in this section.
- ◆ Include the major elements of the deliverables.

It is important to be very clear in the deliverables section. Misinterpretation of project deliverables can establish incorrect customer expectations.

The following are examples of deliverables:

- ◆ Parts
- ◆ Prototypes
- ◆ Procedures
- ◆ Equipment
- ◆ Installation of equipment
- ◆ Written reports
- ◆ Test results
- ◆ Training
- ◆ Specifications
- ◆ Technical drawings
- ◆ Plans



STATEMENT OF WORK (Page 2)

MEASURABLE SUCCESS INDICATORS:

Measurable success indicators include concise, measurable, information that will be used to determine if a project was successful. Measurable success indicators must substantiate any statements made in the background section.

Include what is known about quality, cost, and schedule expectations.

Examples of measurable success indicators include:

- ◆ Complete project in three months
- ◆ Reduce mass by 30%
- ◆ Complete ROI for initial expenditure by Nov. 30, 20xx
- ◆ Achieved \$1.00 reduction in piece cost
- ◆ Demonstrate meeting of EPA Standard # xxxx
- ◆ New process will require two fewer operators
- ◆ Stay within budget of \$275,000.00

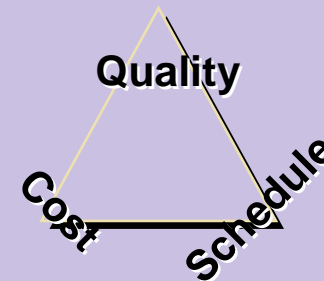

Two specific measurable success indicators which are most important in terms of seeing the “big picture” of a project are:

- ◆ Overall schedule
- ◆ Budget

It’s also important to note any key milestone dates that have been established.

“SMART” is an acronym used to help write good measurable success indicators for a project.

The words which comprise the acronym SMART are:

- ◆ Specific
- ◆ Measurable
- ◆ Agreed upon
- ◆ Realistic
- ◆ Time (cost) framed



Break Timer

Smart Measurable Success Indicators (SMART)

S - Specific

M - Measurable

A - Agreed upon

R - Realistic

I - Time and cost framed



Break Timer



CUSTOMER SUPPORT:

The customer support area provides a means to list the items and services that must be provided by the customer/sponsor to ensure the success of the project. Examples include:

- ◆ Drawings
- ◆ Subject matter experts
- ◆ Equipment
- ◆ Computer time
- ◆ Photocopying
- ◆ Phone/secretarial support

PROJECT RISK PLANS:

The last section of the statement of work is the risk plan. Risk plans consider the possibility of an event occurring that would drastically alter the schedule, budget, or quality of the project.

- ◆ Identify what is likely to go wrong, and also what can have the most impact.
- ◆ Ask “What can go wrong?” “How will I handle it?”
- ◆ Put your statements in “If _____, then _____.” format

Examples of risk plans are:

- ◆ If a labor strike occurs, then outsource production.
- ◆ If supplier cannot ship materials in time, then contact another vendor.
- ◆ If design freeze date is not maintained, then use current product design.



Exercise

Prepare a Statement of Work



Break Timer



Roadmap to Project Management Success

Statement of Work Work Breakdown Structure Responsibility Matrix Network Gantt Resource Plan Budget

Work Breakdown Structure

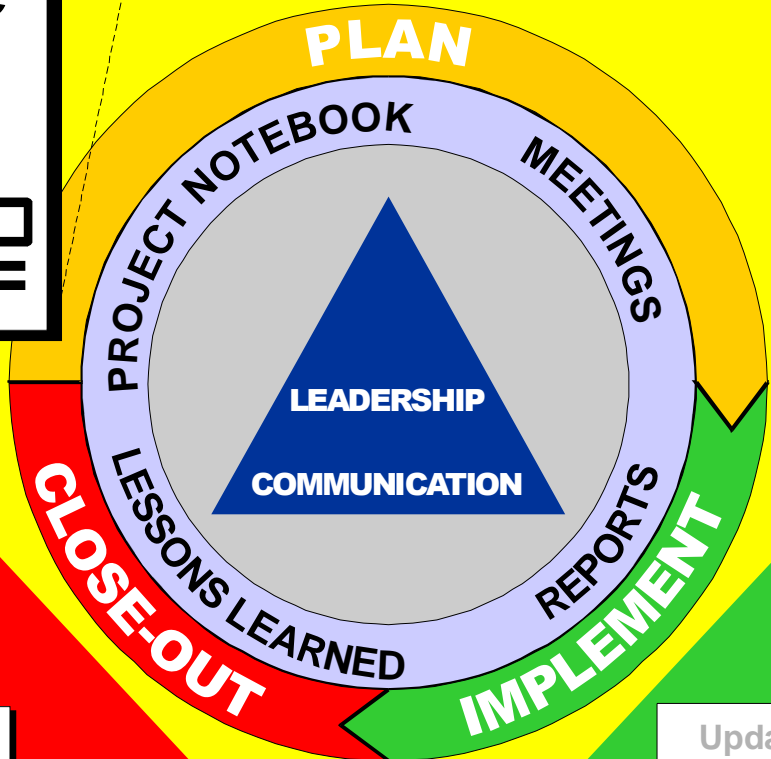
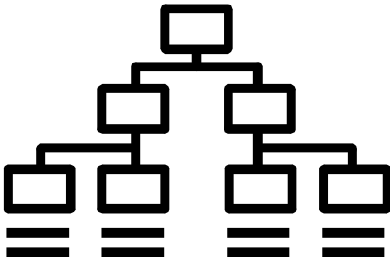

Perform Tasks

Track Progress

Manage Change

Update Plan

Resolve Issues

Evaluate Success

Conduct Close-Out Meeting

Share Lessons Learned

For Project Team

Work Breakdown Structure— Purpose

- ✿ Identify all of the work that needs to be done to complete the project.
- ✿ Structure the work into logical components and subcomponents.
- ✿ Define the work to a level of detail so individual responsibilities can be assigned.
- ✿ Summarize and report project data.



Representative Work Breakdown Structure

Level I
(Noun)

Level II
(Noun)

Level III
(Action Verbs)

Level IV
(Action Verbs)

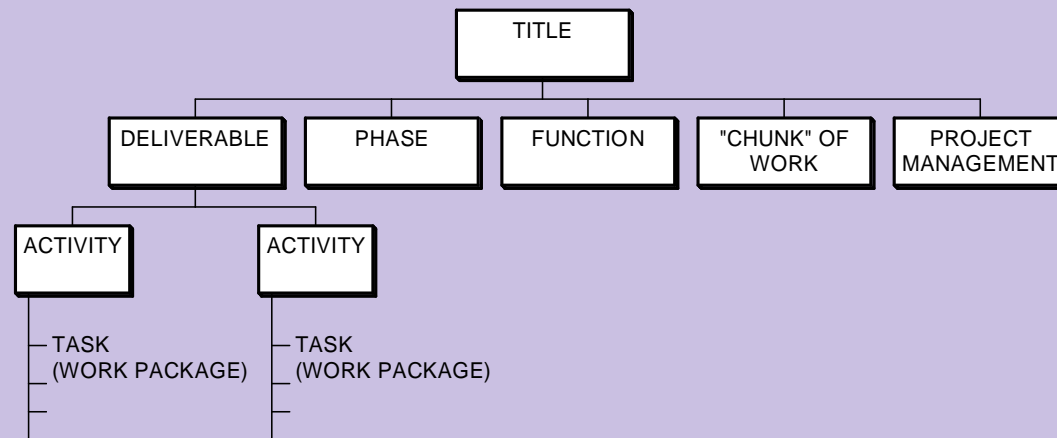

Break Timer

Automotive WBS

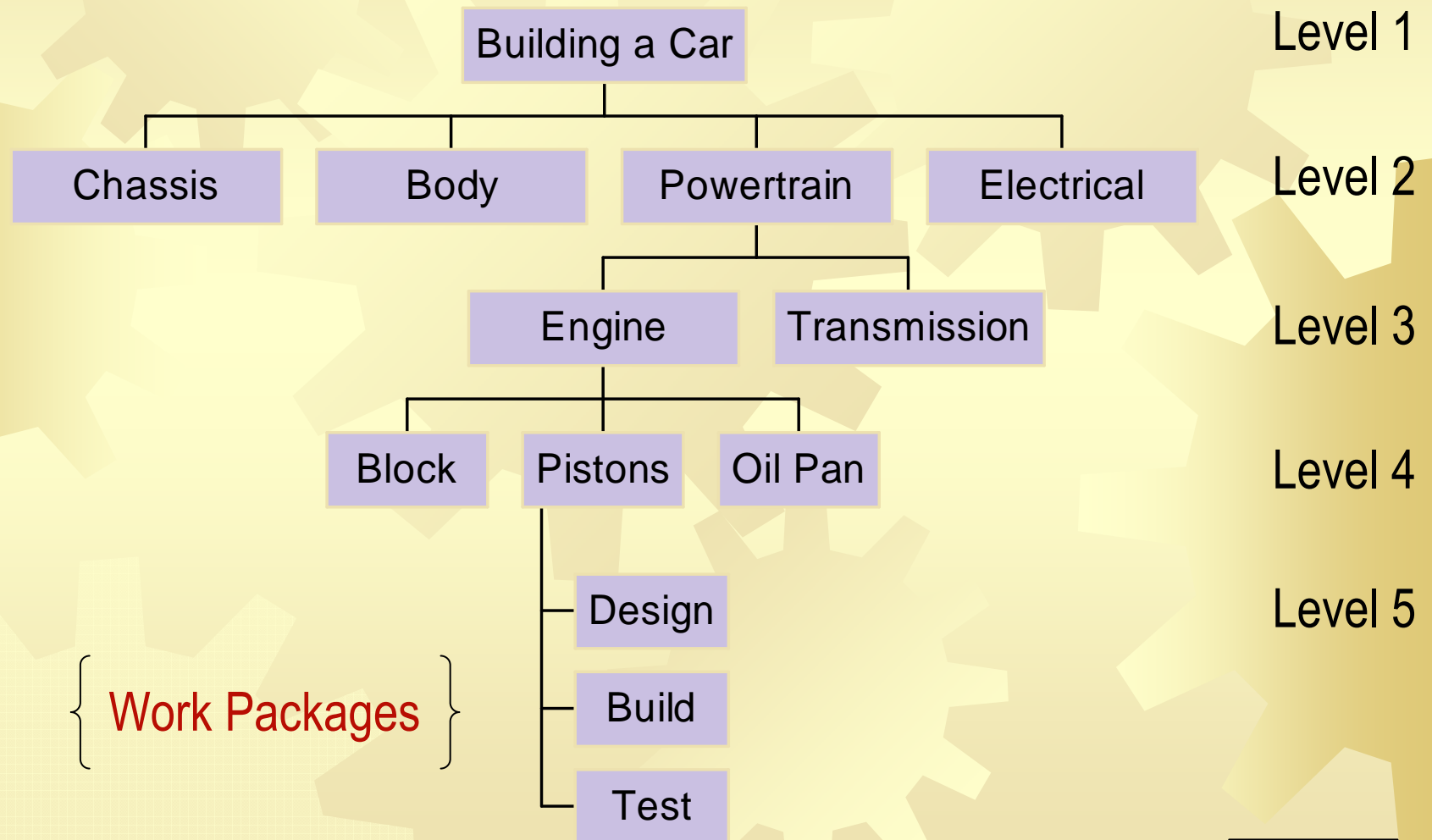

Break Timer



WBS Work Package – Level of Detail

- ★ **WHO** will be the responsible individual or organization?
- ★ How much **TIME** will the activity take?
- ★ What **COST** is associated with accomplishing the activity?
- ★ Can **PROGRESS** be tracked easily?



Break Timer



WBS — Outlining Approach

3-4-10

- I. Main Project Deliverable **Level 1**
 - A. Major Element **Level 2**
 - 1. Activity **Level 3**
 - 2. Activity **Level 3**
 - a. task **Level 4**
 - b. task
 - c. task
 - 3. Activity **Level 3**
 - B. Major Element **Level 2**
 - 1. Activity **Level 3**
 - 2. Activity **Level 3**

The outline approach is used by Microsoft® Project®



Break Timer



Exercise

Create a WBS



Break Timer



Roadmap to Project Management Success

Form Project Team



Statement of Work



Work Breakdown



Responsibility Matrix



Network

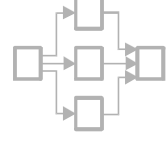

Gantt



Resource Plan



Budget



Responsibility Matrix

	R	A	
		A	S
	S	R	

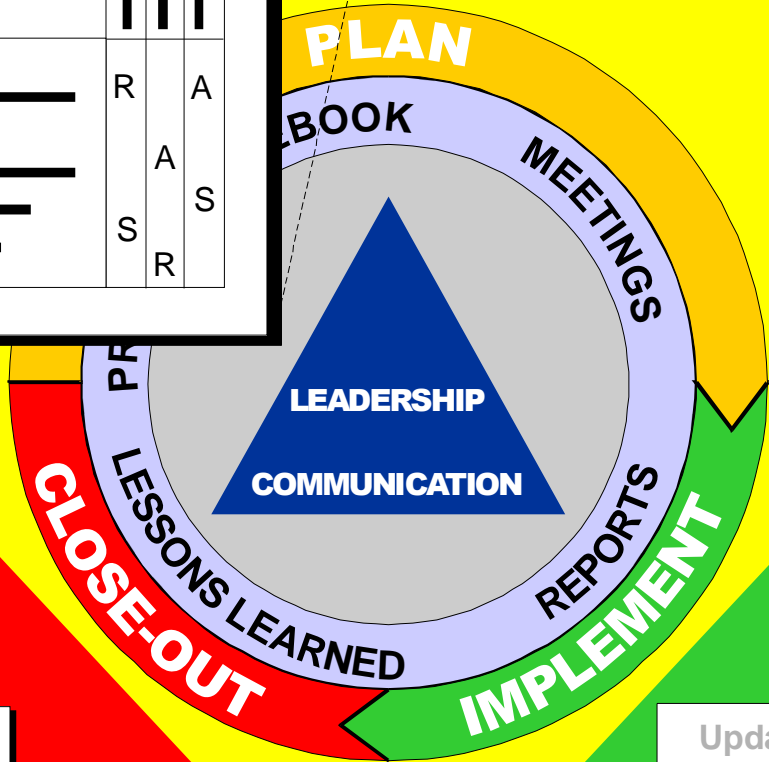

Conduct Close-Out Meeting



Perform Tasks



Track Progress



Share Lessons Learned



Evaluate Success



Update Plan



Resolve Issues



Manage Change



Responsibility Assignment Matrix (RAM) — Purpose

- ✿ Ensure that all tasks are assigned to people
- ✿ Show levels of involvement of people to work



Break Timer



Responsibility Assignment Matrix

RASIC Method

MARKETING STUDY	PROJECT MANAGER	CUSTOMER	TEAM MEMBER	SENIOR MANAGEMENT	SUPPORT STAFF
IDENTIFY POTENTIAL MARKET	C		S	R	
IDENTIFY SURVEY POPULATION	C	R	S	I	
DEVELOP SURVEY	R	I	S	I	
TEST SURVEY ON SAMPLE	R	I	S		S
FINALIZE SURVEY	R	A	S	I	S
CONDUCT SURVEY	R	I	S	I	S
COLLECT SURVEY	R	I	S		
ANALYZE DATA			R/S		I
REPORT RESULTS AND SUGGESTION	R	A	S	A	S

LEGEND

R - RESPONSIBLE
 A - APPROVE
 S - SUPPORT (DOES THE WORK)
 I - INFORM
 C - CONSULT

RASIC Coding System

- ✿ R = Responsible
 - ✿ Ensures that the assigned work is completed, responsible for the delivery.
- ✿ A = Approve
 - ✿ Approves that the work meets all requirements.
- ✿ S = Support
 - ✿ Does the work. Committed to its completion
- ✿ I = Inform
 - ✿ Is kept informed of work status, no decision making
- ✿ C = Consult
 - ✿ Is consulted on the work. Provides input.



Break Timer



Roadmap to Project Management Success

Form Project Team



Statement of Work

Purpose
Project Background
Project Deliverables

Work Breakdown

Responsibility Matrix

Network

Gantt

Resource Plan

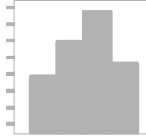

Budget

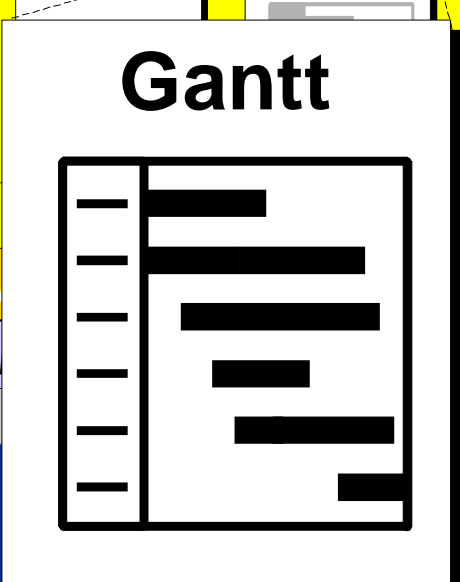
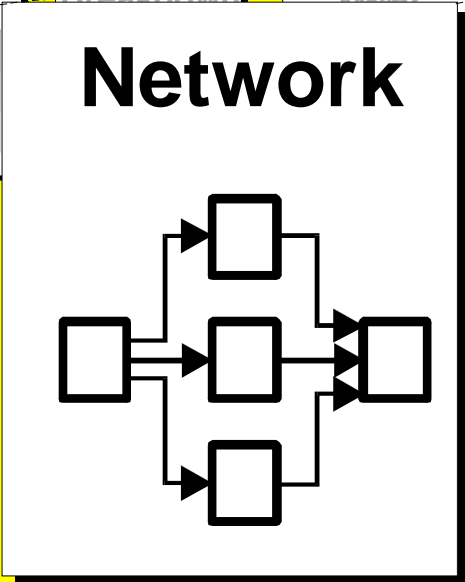
Conduct Close-Out Meeting



Share Lessons Learned

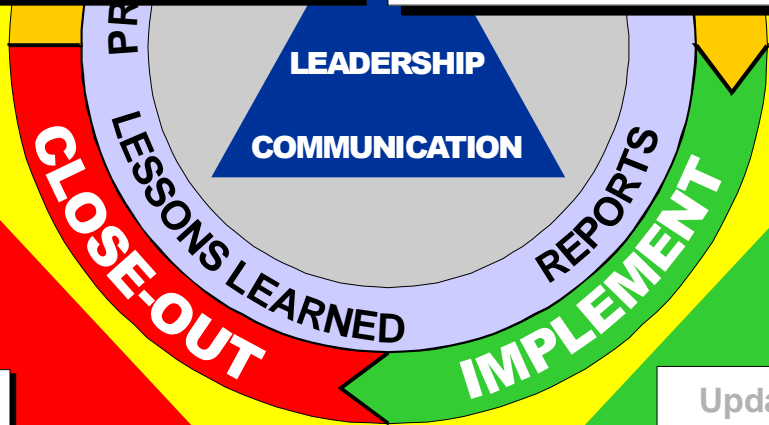

Evaluate Success

Perform Tasks



Track Progress



Update Plan



Resolve Issues



Manage Change



Project Schedule — Purpose

- ✿ Determine if requested completion date is possible.
- ✿ Identify start and completion dates of all work.
- ✿ Determine the controlling sequence of activities.
- ✿ Provide data for resource allocation.
- ✿ Track progress by providing a baseline.



Break Timer

Scheduling

Step 1: Estimate Activity Durations

Step 2: Determine Activity Sequence By Creating a Network Diagram

Step 3: Calculate the Schedule Using Critical Path Method (CPM) Procedures

Step 4: Show the Schedule by Drawing Gantt and/or Milestone Charts



Break Timer



Estimate activity duration

- Expert judgment
 - Individuals who have performed similar activities.
- Analogous estimating
 - Use similar projects to estimate this one.
- Three point estimate (PERT – project evaluation and review technique)

$$\text{estimate} = \frac{\text{pessimistic} + (4 \text{ times realistic}) + \text{optimistic}}{6}$$



WBS/Network Diagram Linkage

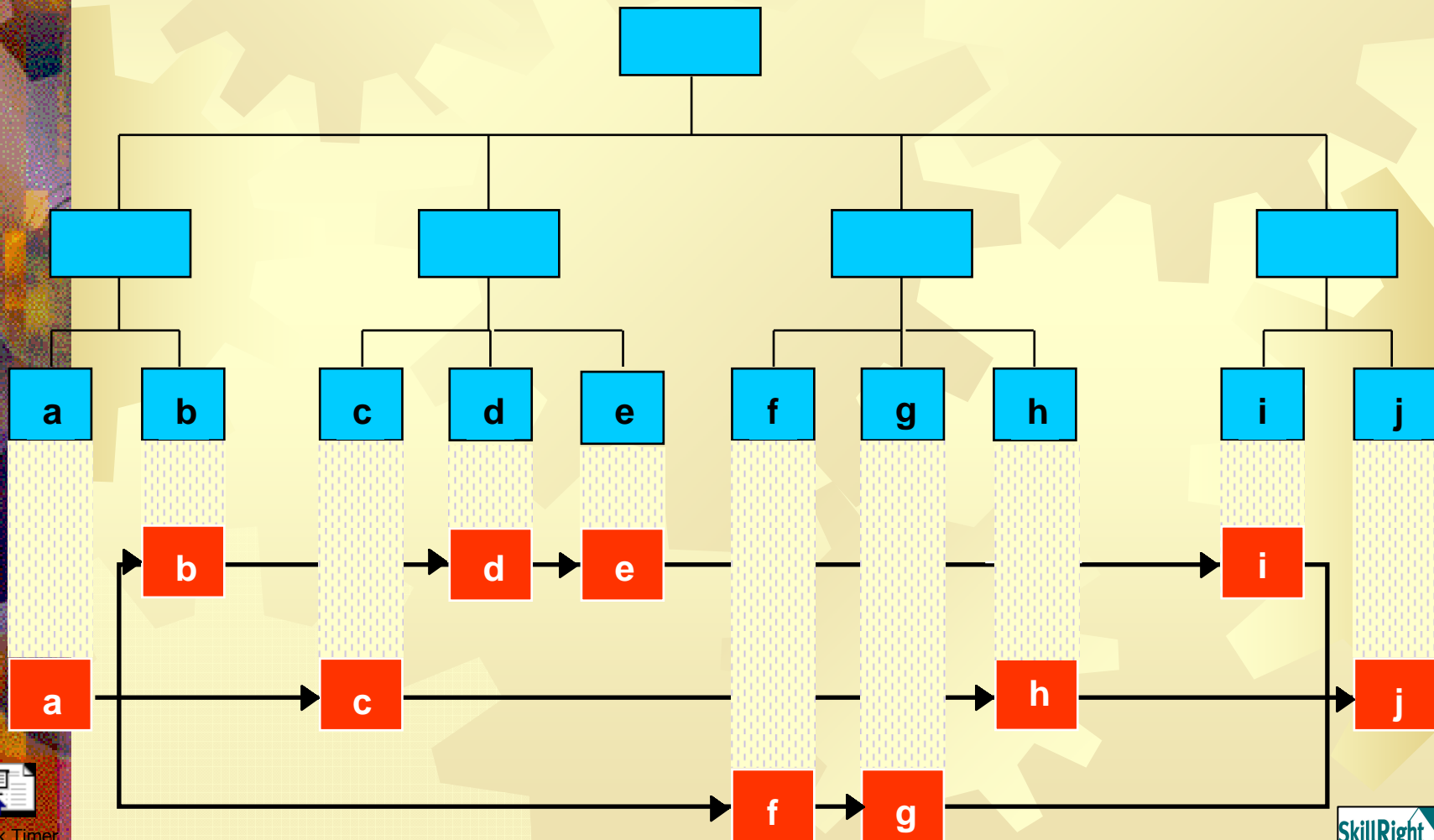

Break Timer



Network Diagram Methods

Arrow Diagram Method

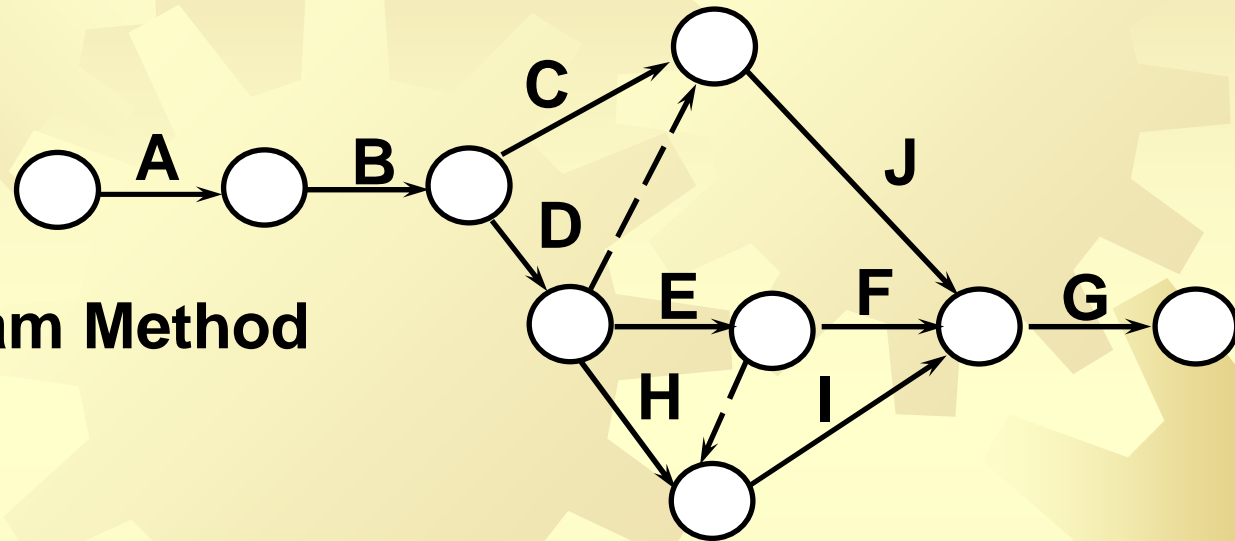

Precedence Diagram Method

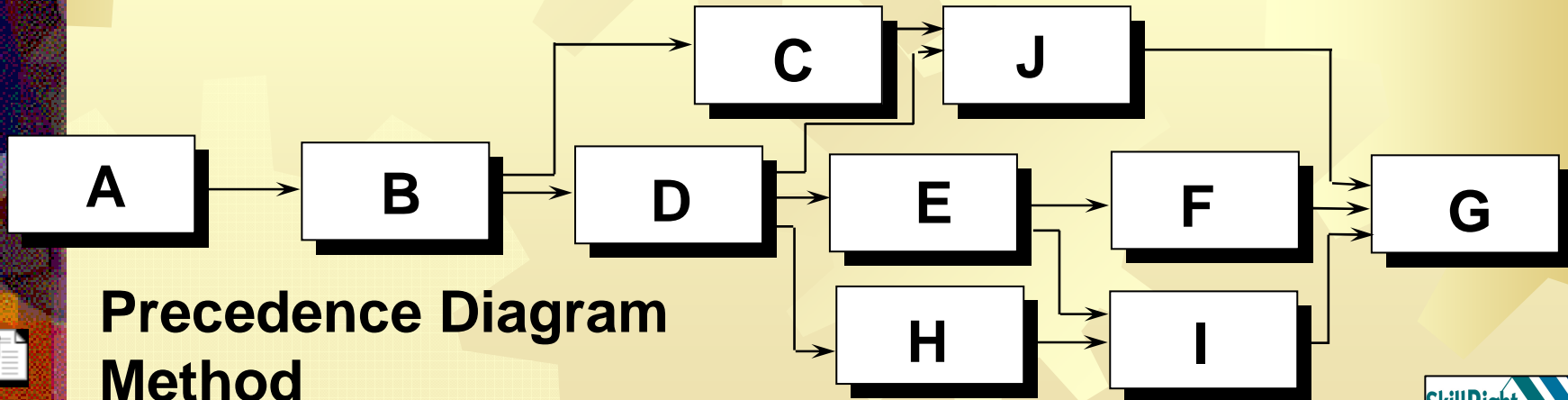

Break Timer

Precedence Diagram Method

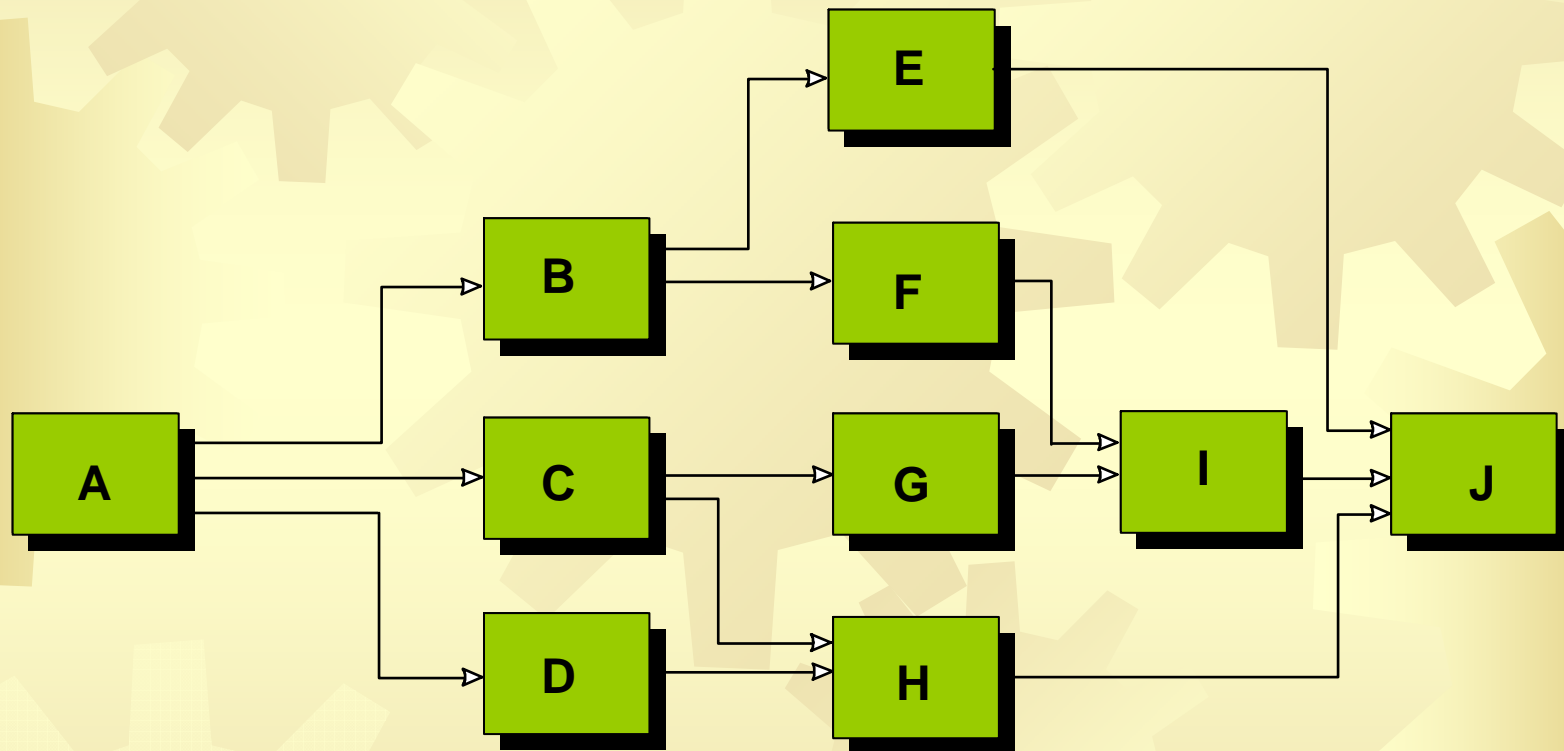

→ **Logic Connection**

 **Activity**



Break Timer

What's is the Critical Path?

- ✿ Path with least slack
- ✿ Path with longest duration
- ✿ ***Critical Path Method*** is a project management technique that analyzes what activities have the least amount of scheduling flexibility (i.e., are the most mission-critical) and then predicts project duration schedule based on the activities that fall along the “critical path.”
 - ✿ Activities that lie along the critical path cannot be delayed without delaying the finish time for the entire project.



Project X — Critical Path Solution

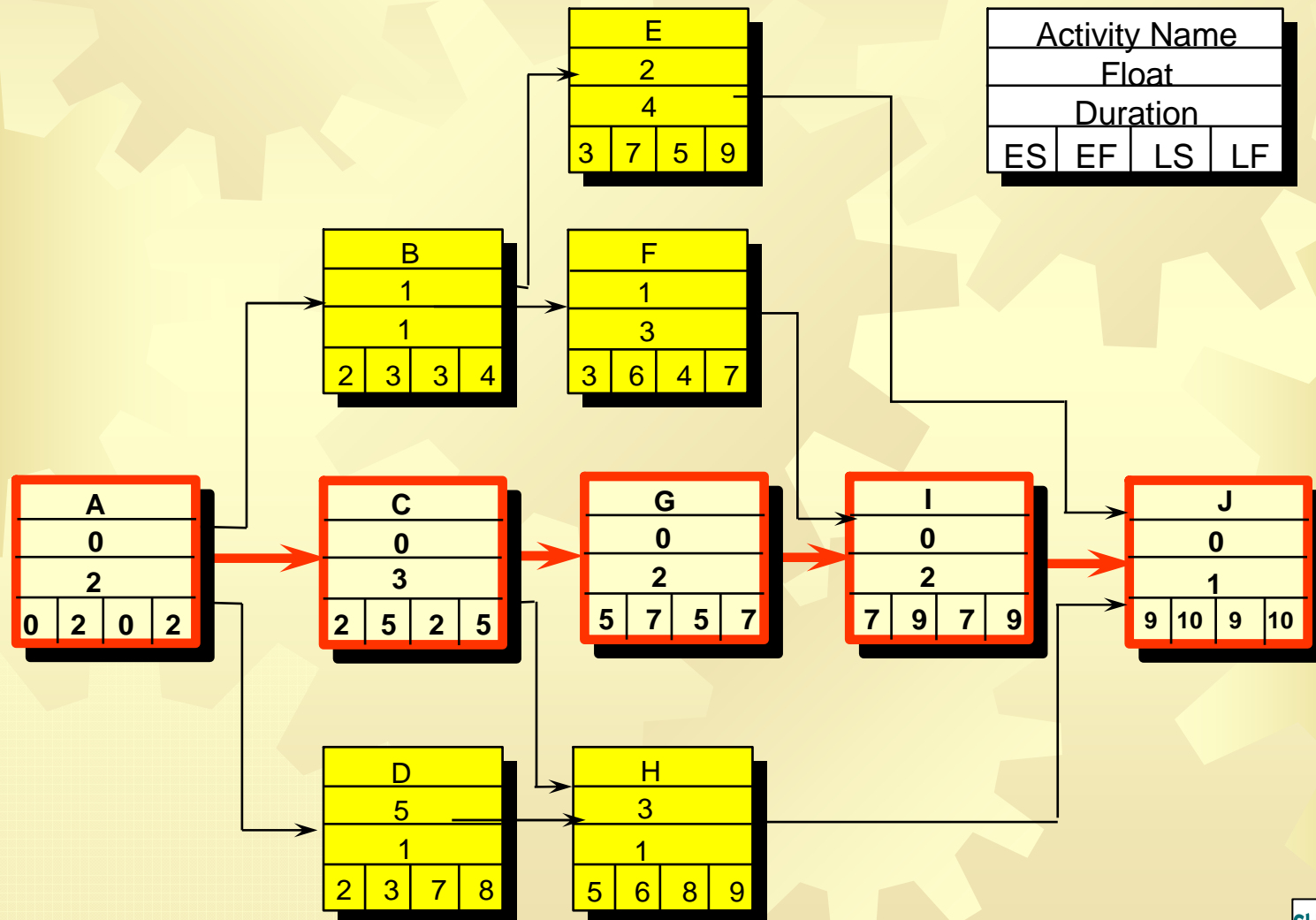

Break Timer

Enhanced Gantt Chart

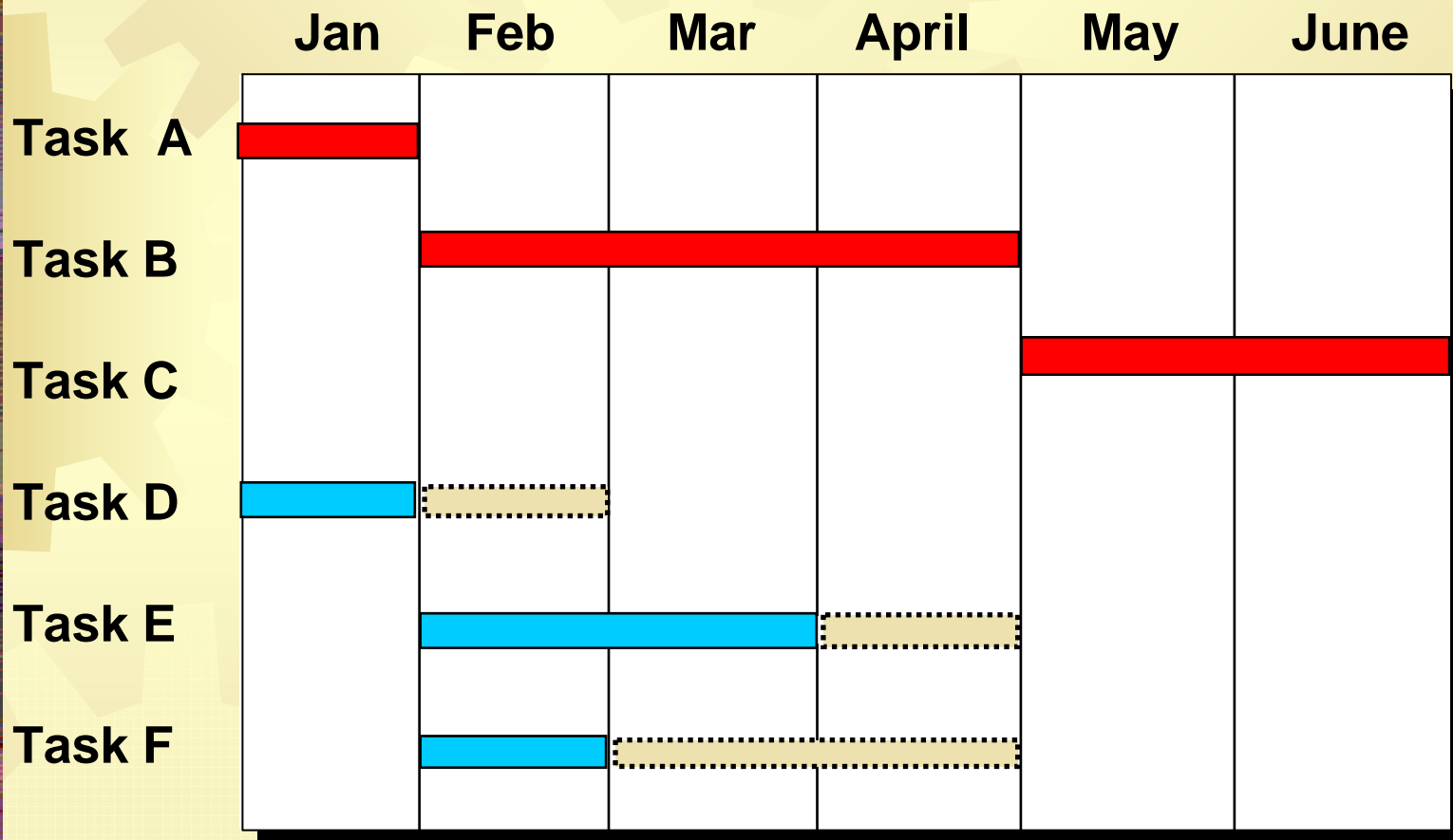

Break Timer

 - Critical  - Non-Critical  - Slack/Float



Project X — Gantt Chart Solution

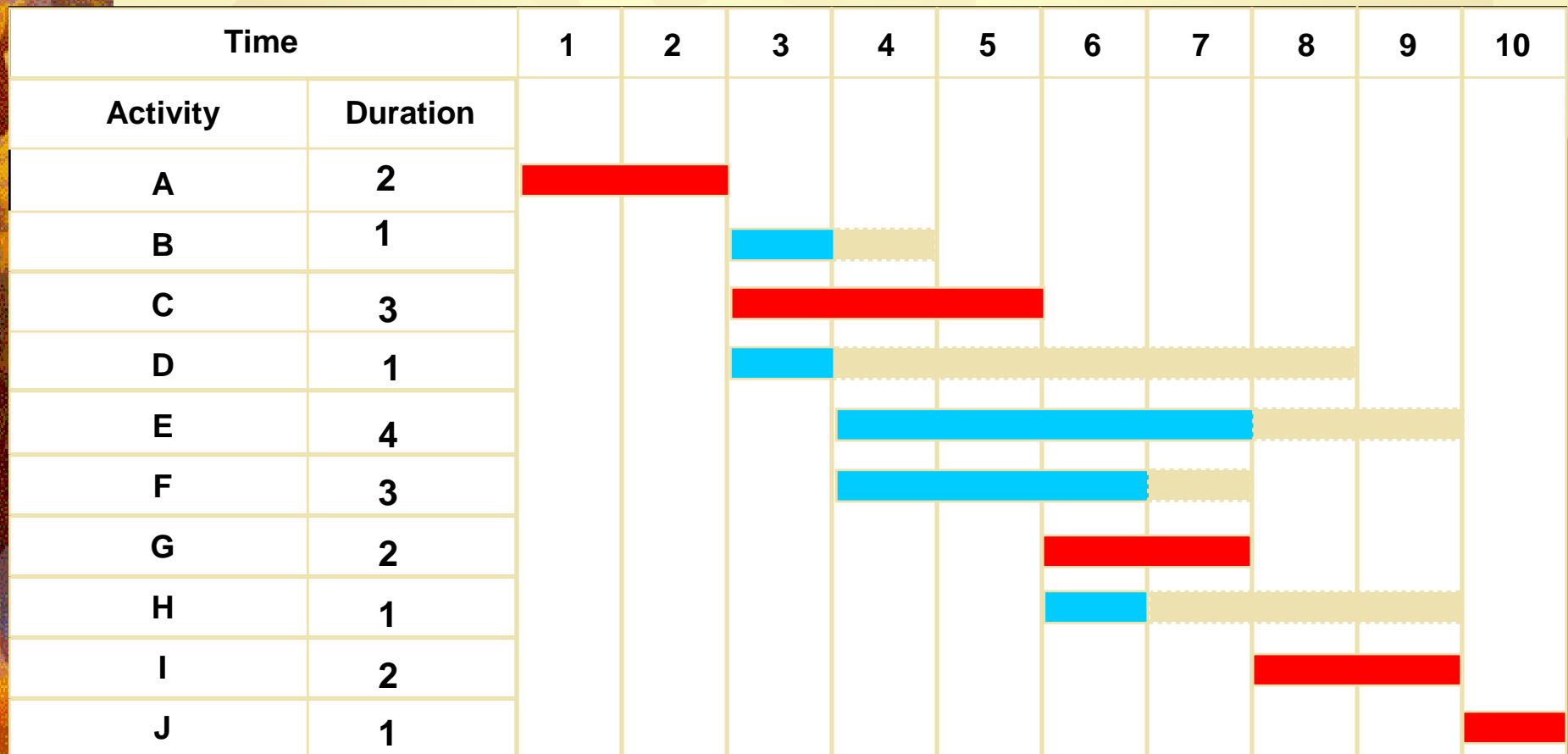

Break Timer

- Critical
 - Non-Critical
 - Slack/Float



Exercise

- ✿ Prepare a project schedule for your project.

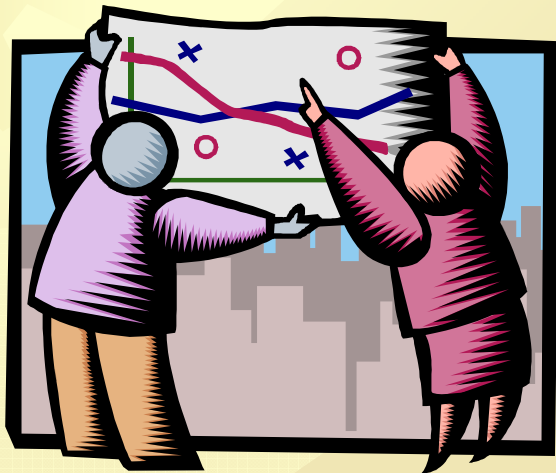

Break Timer

Roadmap to Project Management Success

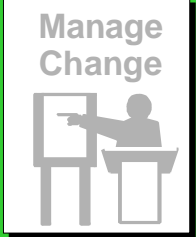
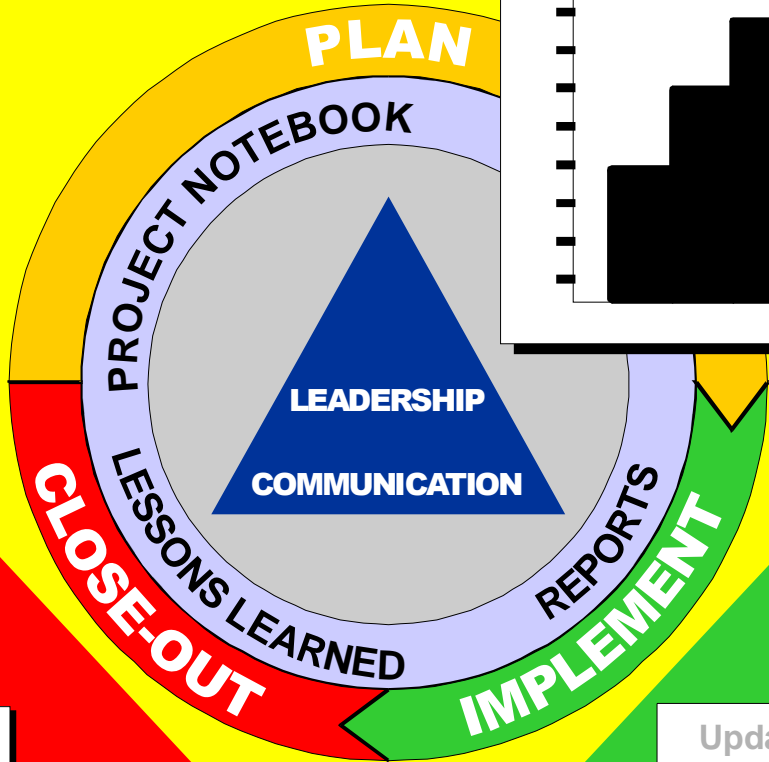
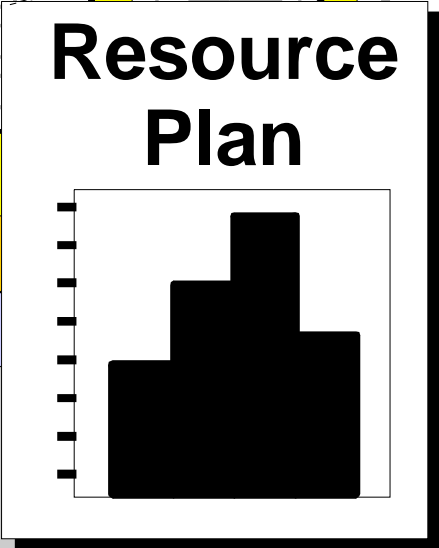
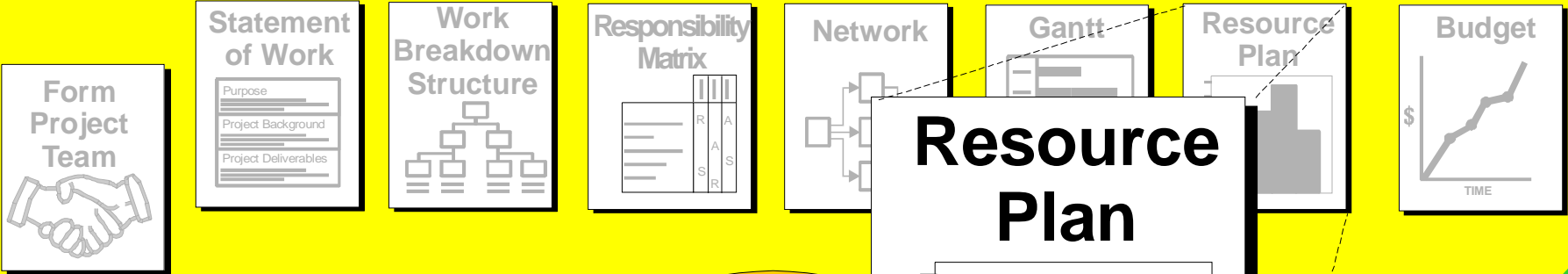

Assigning Resources

A schedule is not complete until all the resources necessary to complete the project have been committed or assigned.

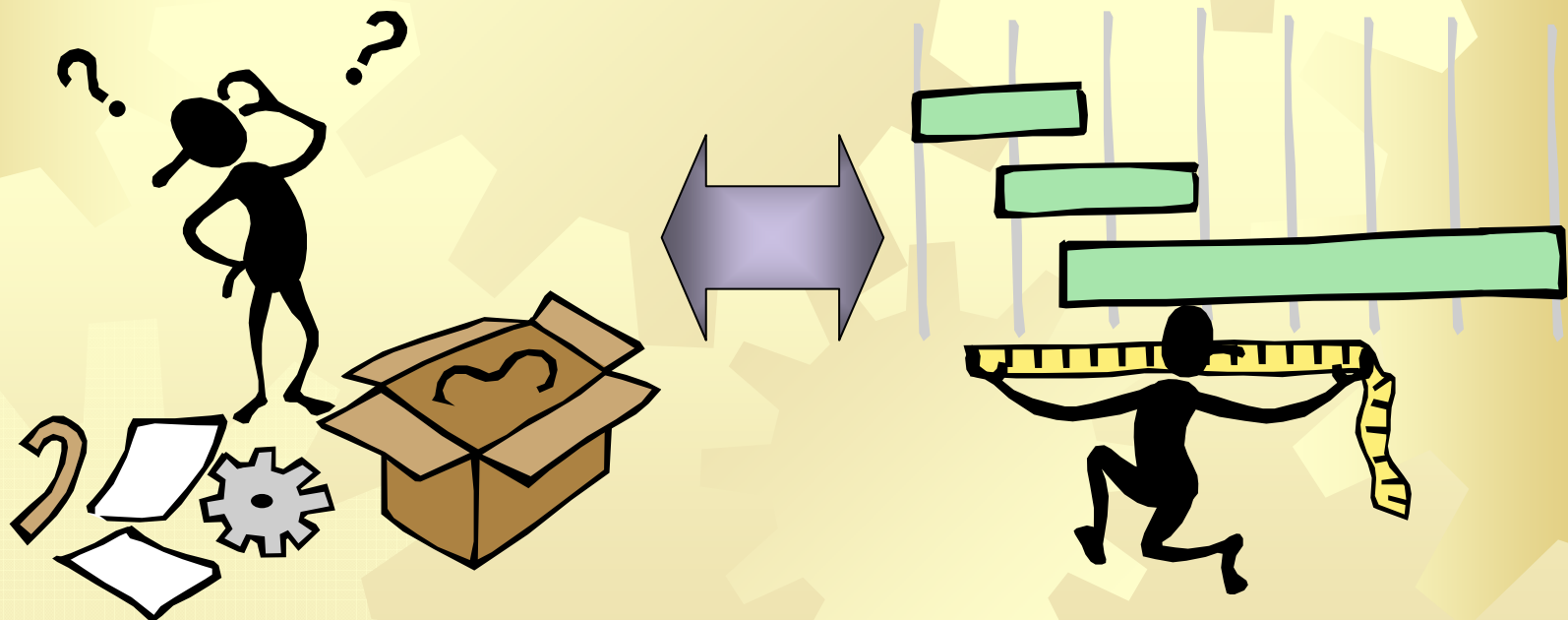

Factors to Consider

- ✿ Availability of other resources
- ✿ Depletion of available float time
- ✿ Impact on critical path
- ✿ Impact on budget



Non-Labor Resources

- Lab time
- Facilities
- Prototype parts/systems
- Equipment
- Materials

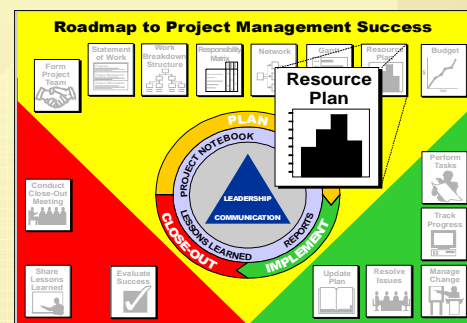
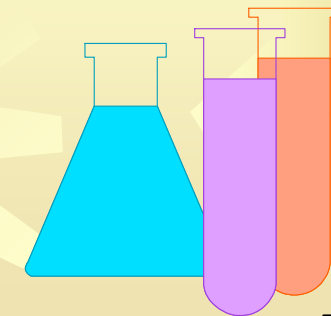
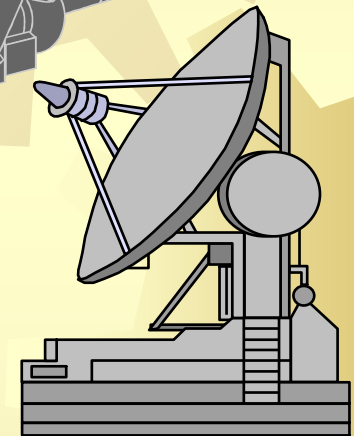
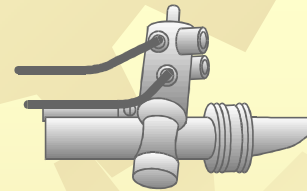
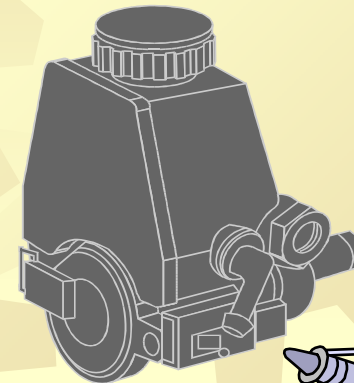

Break Timer



Roadmap to Project Management Success

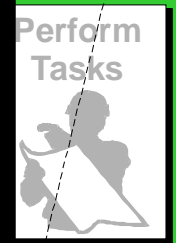
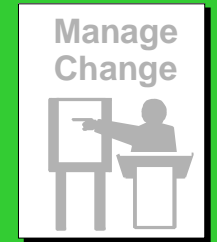
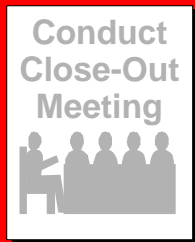
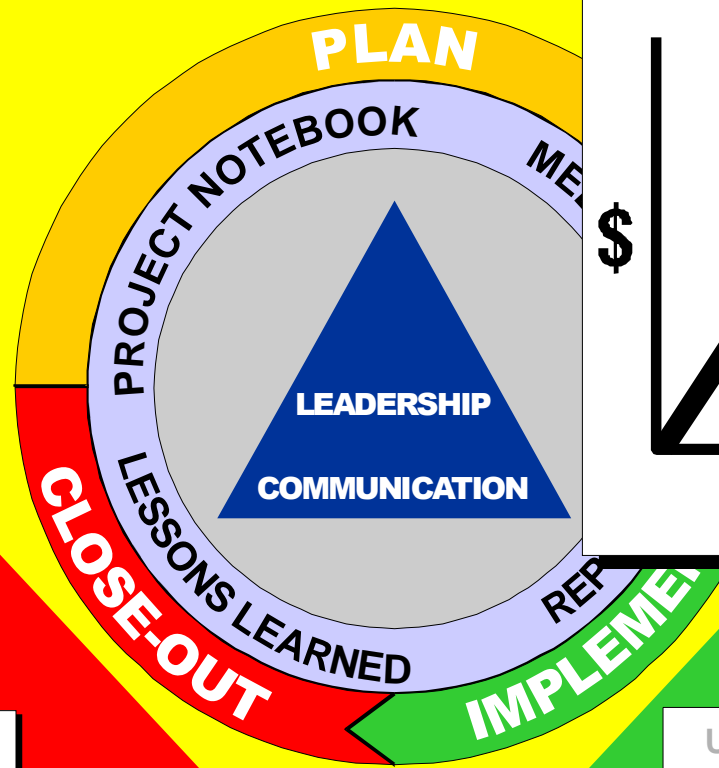
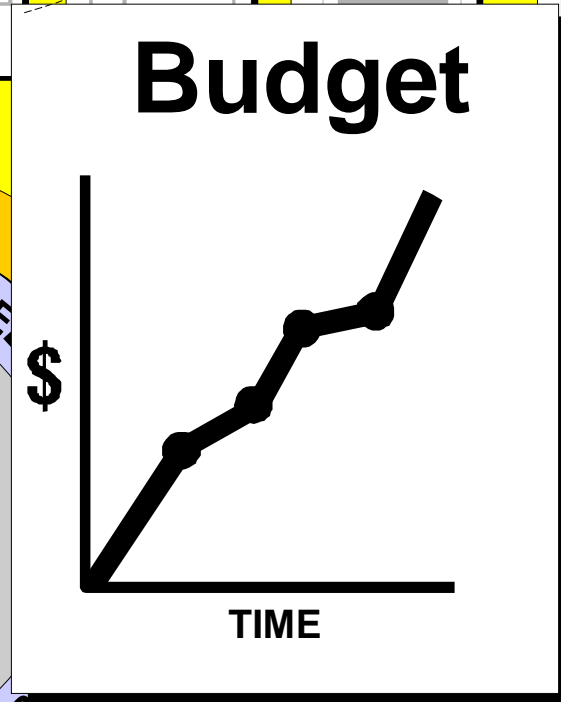
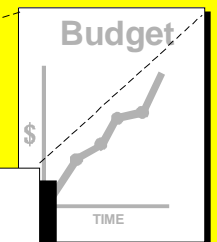
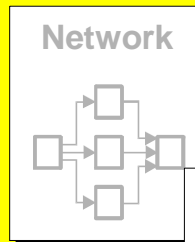
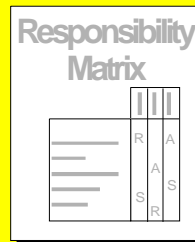
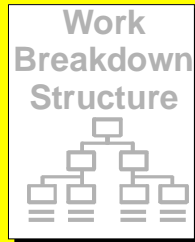
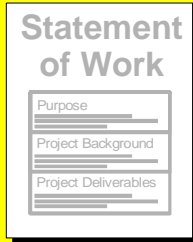

Estimating costs

- The costs of a project are derived from the WBS, schedule, resources, and risks.
- Include
 - Labor
 - Equipment—remember S/H
 - Supplies —remember S/H
 - Materials—remember S/H
 - Travel
 - Training
 - Overhead
 - Contingency plan

Source: PMI



Break Timer



Roadmap to Project Management Success

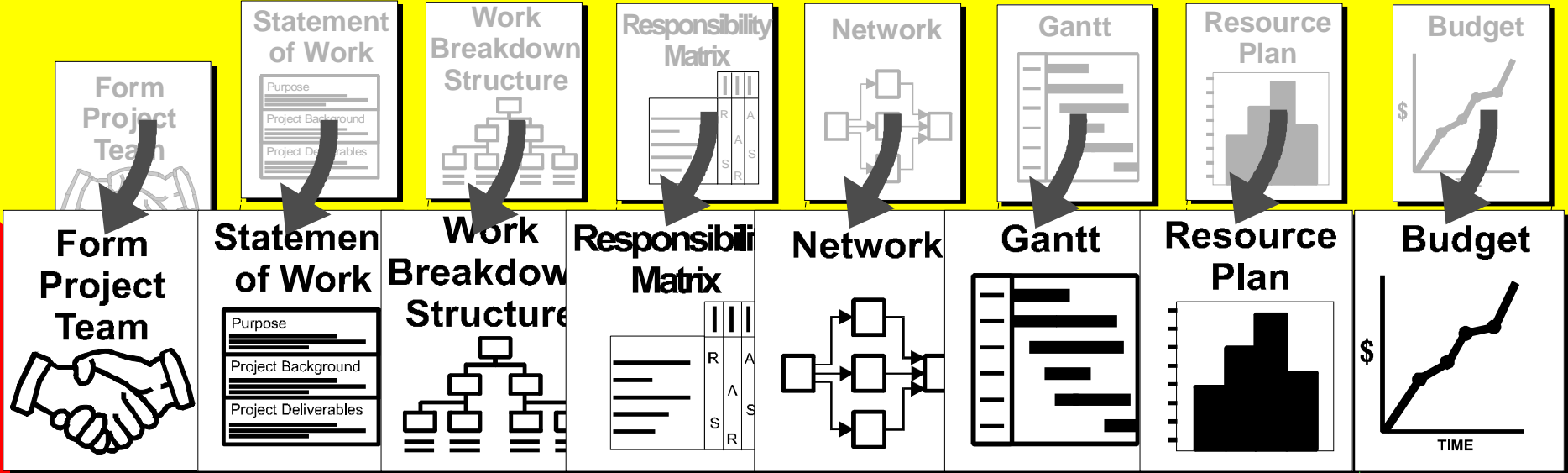

Conduct Close-Out Meeting

Share Lessons Learned

Evaluate Success

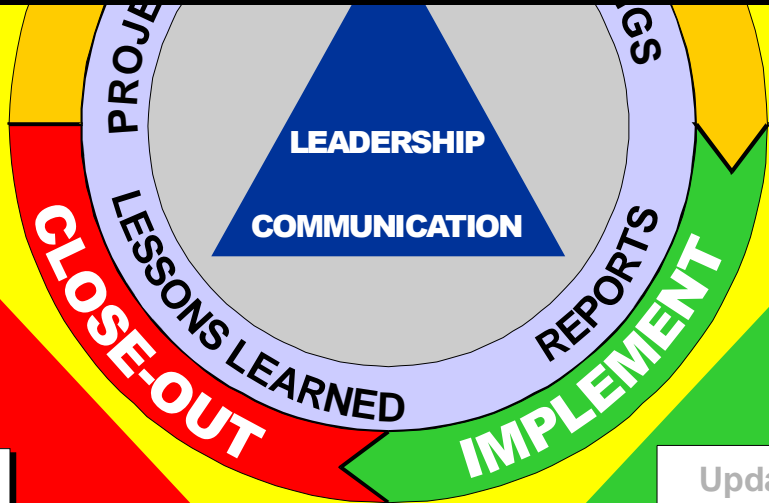

Track Progress

Update Plan

Resolve Issues

Manage Change

What Is Risk?

Risk can be defined as:

“Any threat to project success.”

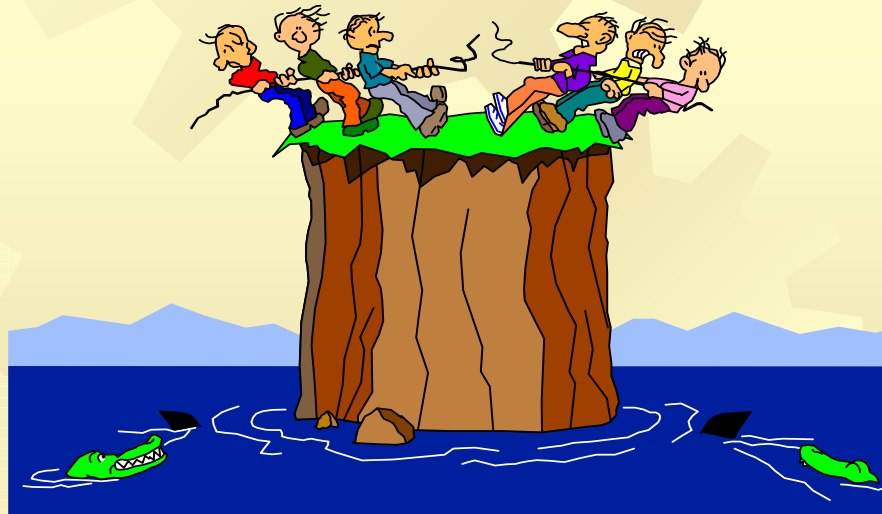

Break Timer



Project Scope

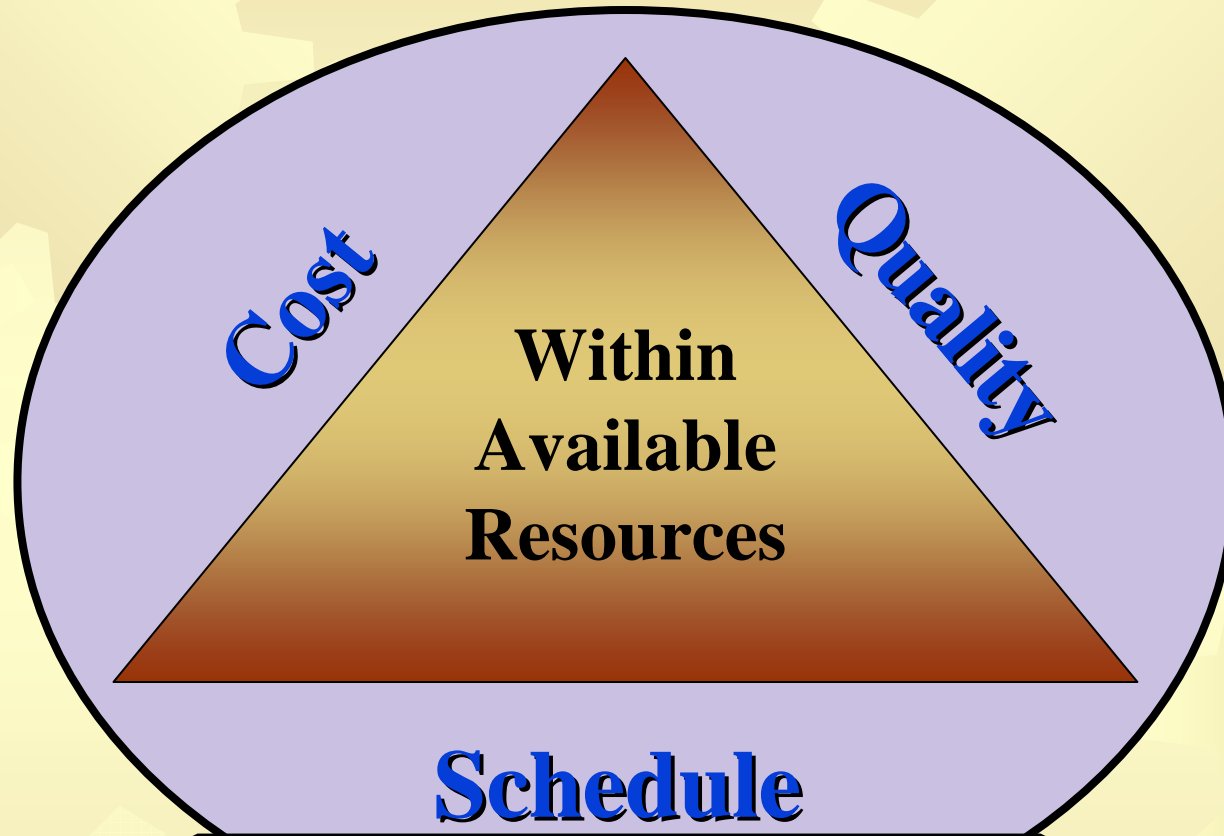

Project Risk



Break Timer



Risk Management

“Risk Management is the art and science of identifying, analyzing and responding to risk factors throughout the life of the project and in the best interests of its objectives.”

Source: PMI



Break Timer



Risk Plan Development

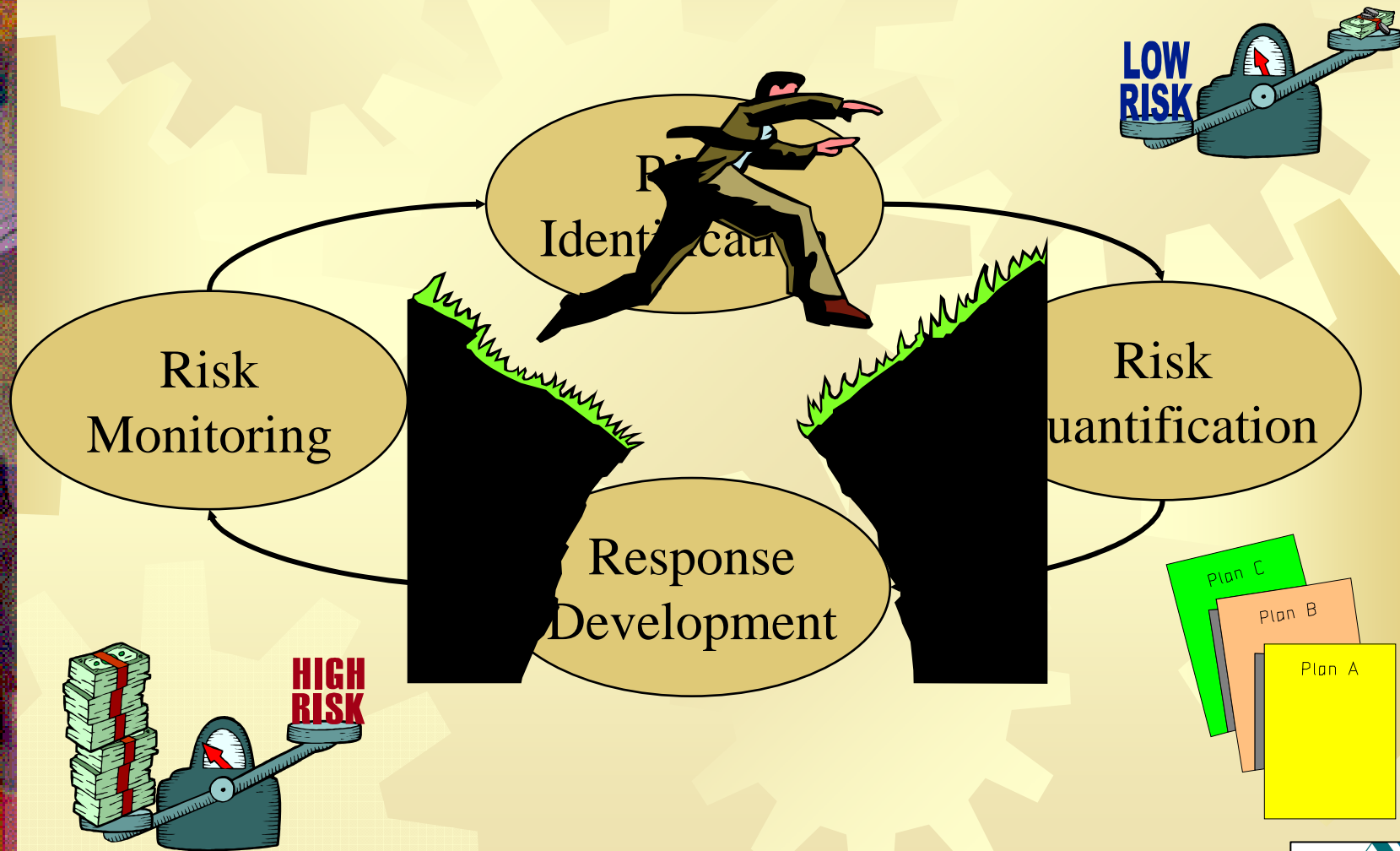

Break Timer

Prioritizing & Planning

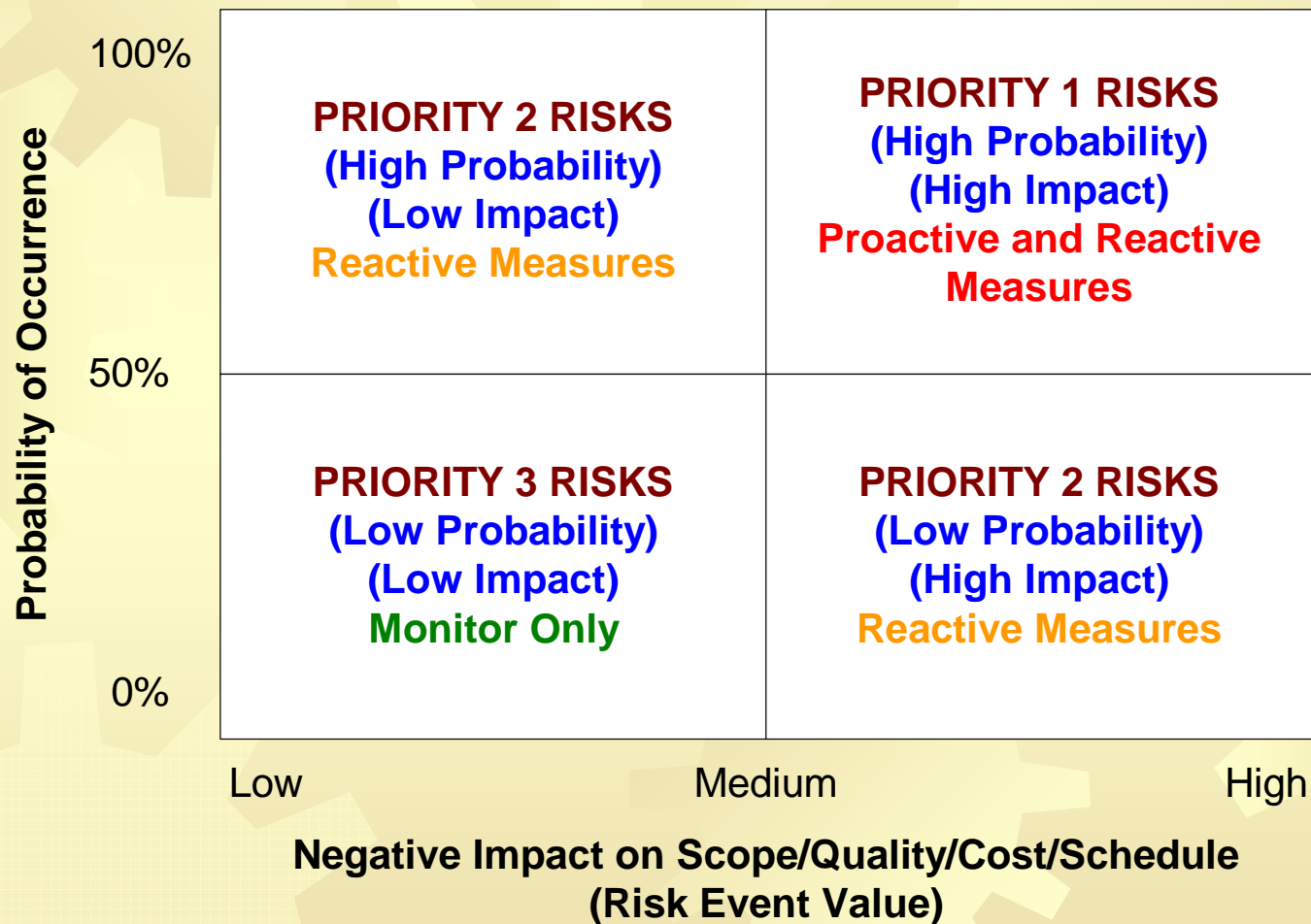

Break Timer



End of Planning Phase



Break Timer



Project Management Process

Source: PMBOK

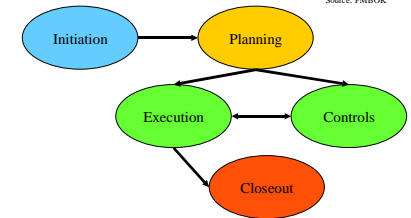

Project Implementation



Break Timer



Roadmap to Project Management Success

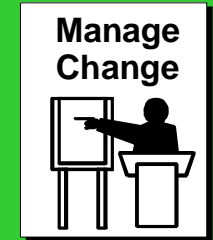
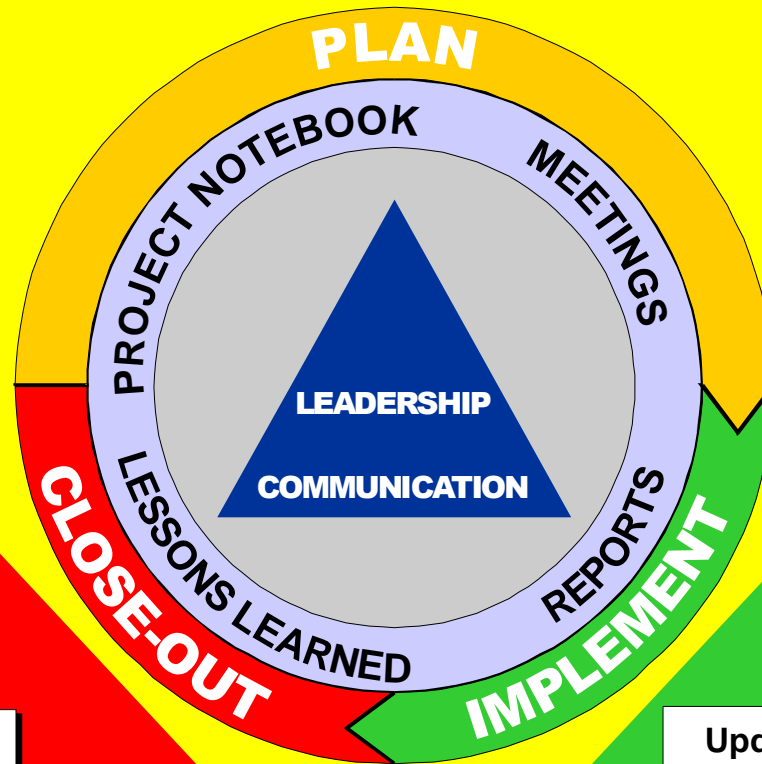
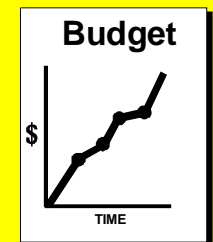
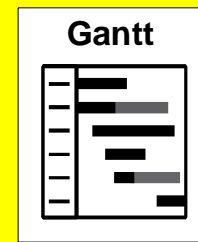
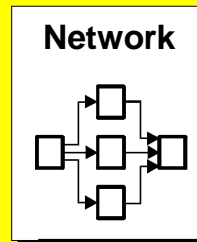
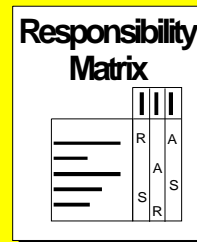
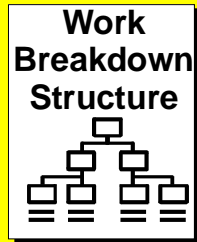
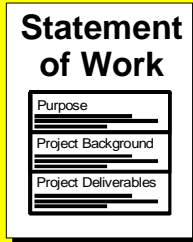

Implementation Model



Break Timer

Roadmap to Project Management Success



Statement of Work

- Purpose
- Project Background
- Project Deliverables

Work Breakdown Structure

Responsibility Matrix

	R	A	
	S	A	S

Network

Gantt

Resource

Budget

Perform Tasks

Perform Tasks

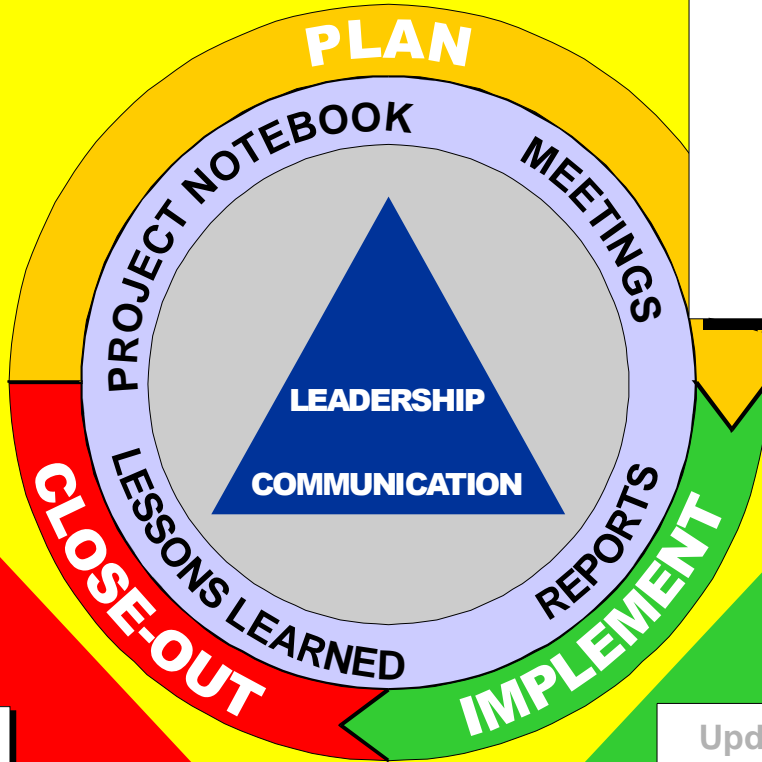

Conduct Close-Out Meeting

Track Progress

Share Lessons Learned

Evaluate Success

Update Plan

Resolve Issues

Manage Change

Reporting Project Progress

- ✿ Progress review meeting
- ✿ Project reports



Break Timer

Project Progress Review Meetings

- ★ Review of action items from last meeting
- ★ Update on activities and schedule
- ★ Problem identification and corrective action planned
- ★ Review of issues (closed, open, new)
- ★ Change request status
- ★ Risk status
- ★ Plan for next period



Break Timer

Roadmap to Project Management Success

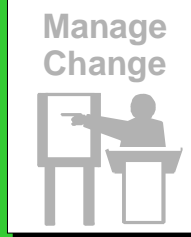
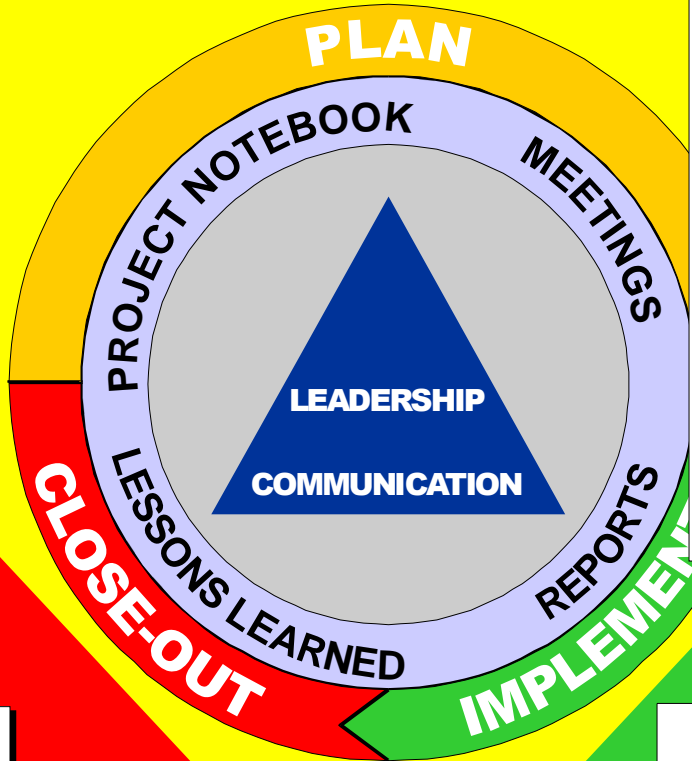
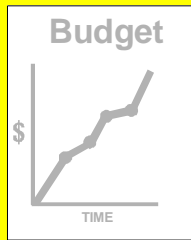
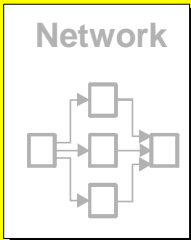
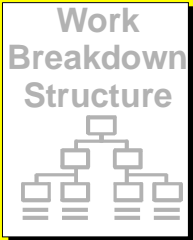
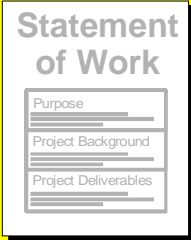

Project Tracking and Control

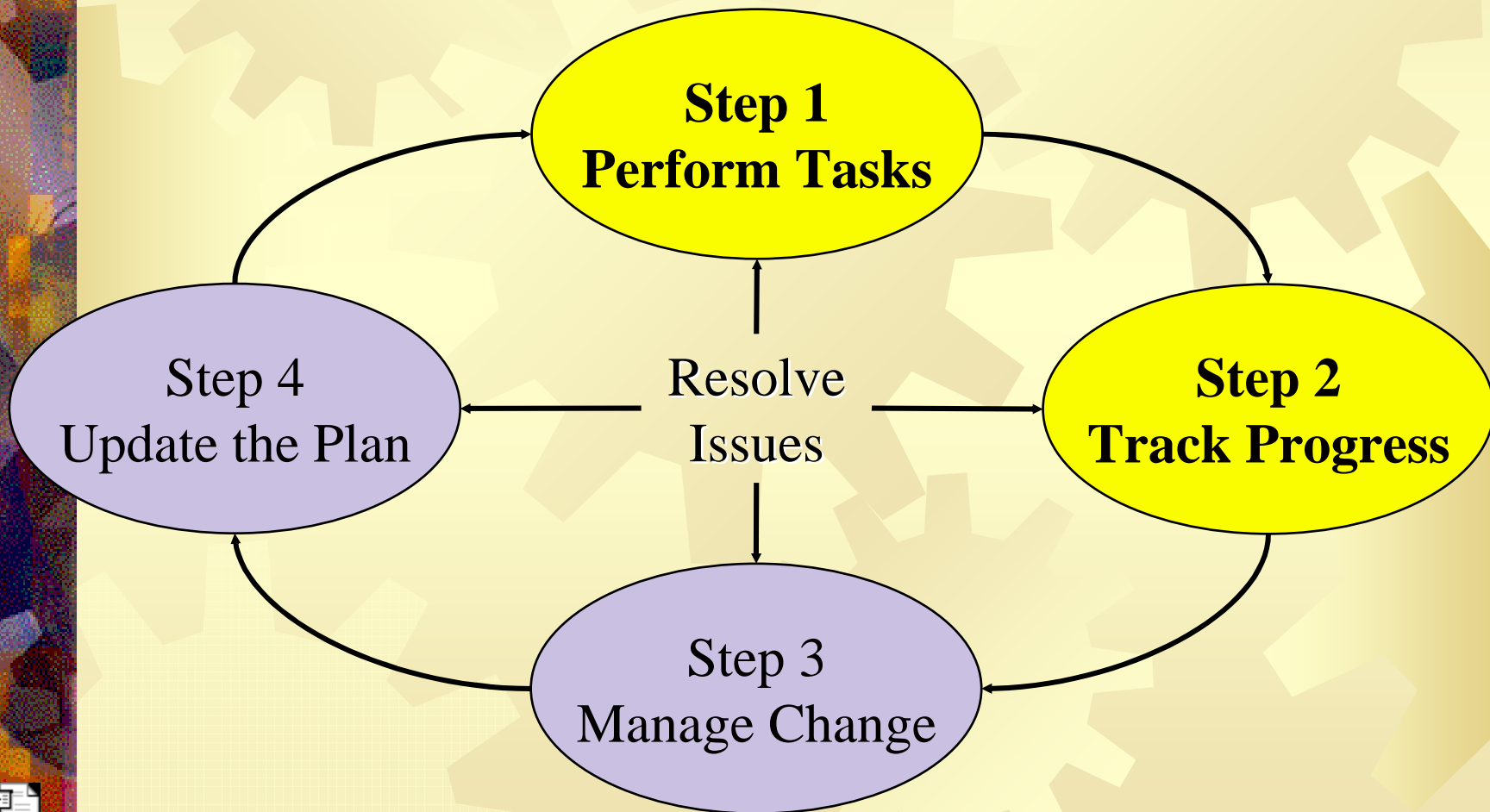

Break Timer

Compare Progress to Plan

- ★ Quality reviews
- ★ Gantt schedule performance charts
- ★ Cost performance charts



Break Timer

Cost Performance

Week	Planned Value	Actual Costs
1	\$3,000	\$8,000
2	\$6,000	\$16,000
3	\$18,000	\$30,000
4	\$30,000	\$48,000
5	\$44,000	\$66,000
6	\$54,000	
7	\$64,000	
8	\$80,000	
9	\$83,000	
10	\$89,000	



Break Timer

Cost Performance Chart

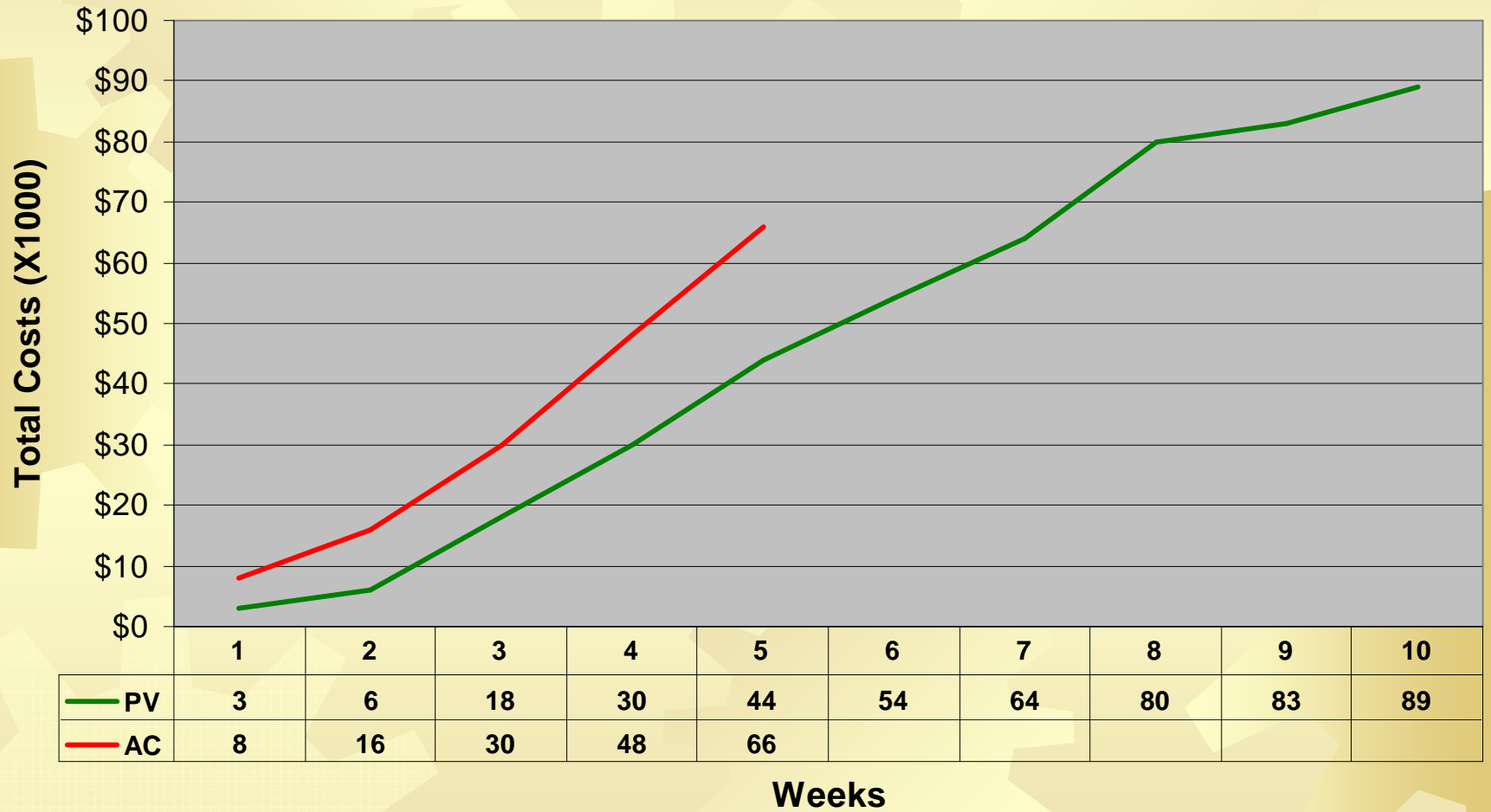

Break Timer



Roadmap to Project Management Success

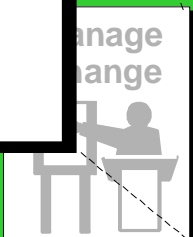
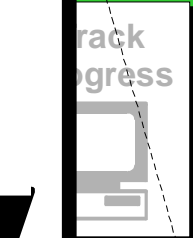
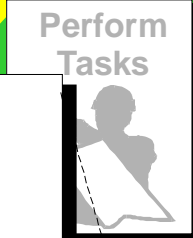
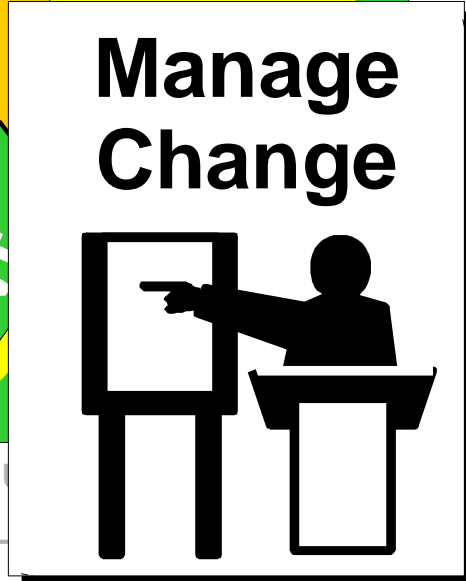
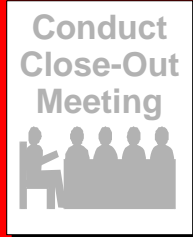
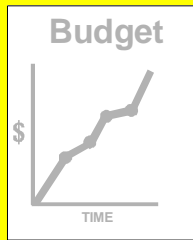
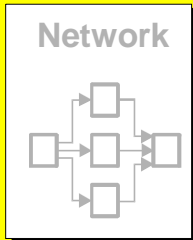
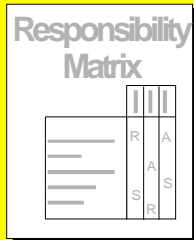
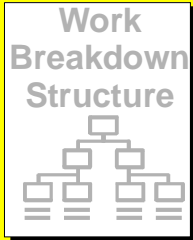
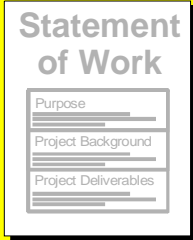

Managing Project Change

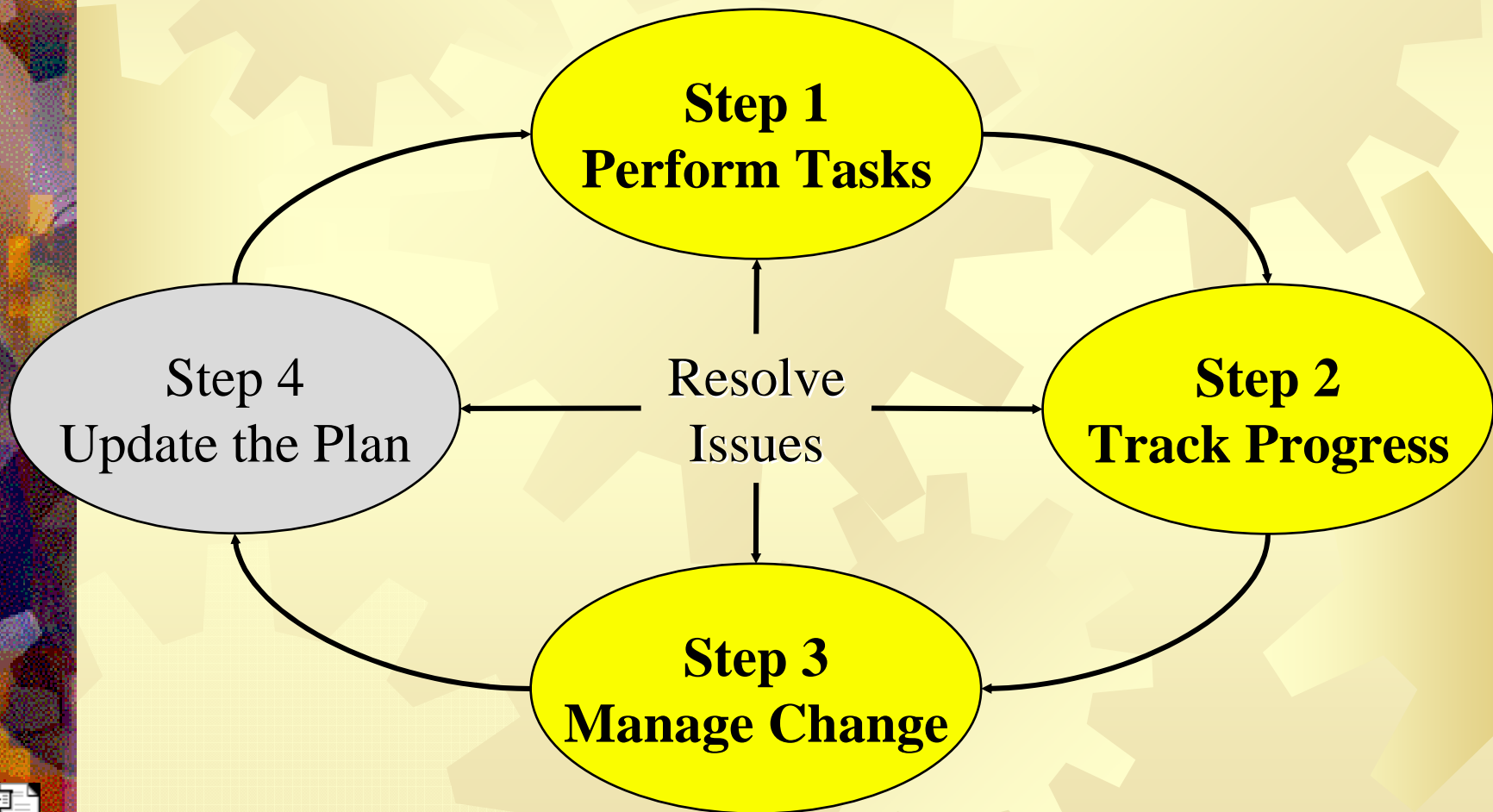

Break Timer

Categories of Change

- Customer requested
 - Typically the largest source of change
- All others
 - Internal company requests
 - Government regulation
 - Team members

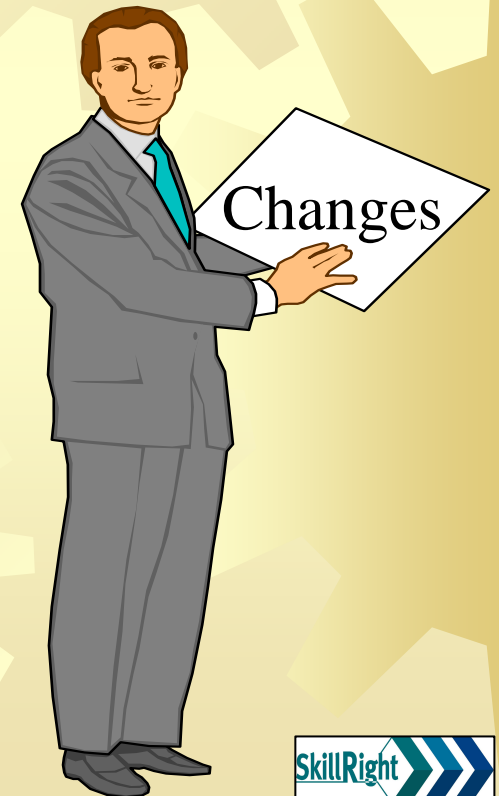

Break Timer



Addressing Project Changes

- ✿ Call a team meeting.
- ✿ Explain what the change is.
- ✿ Obtain feedback from team members.
- ✿ Identify alternative corrective options.
- ✿ Prepare a decision matrix.
- ✿ Select a recommended option(s).
- ✿ Present information to upper management/customer.
- ✿ Implement the approved course of action.



Break Timer

Roadmap to Project Management Success

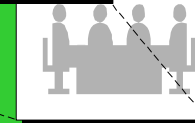
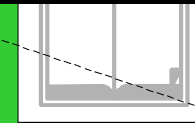
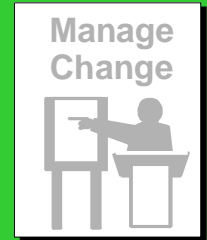
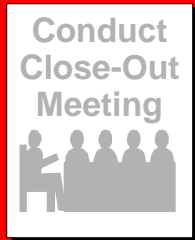
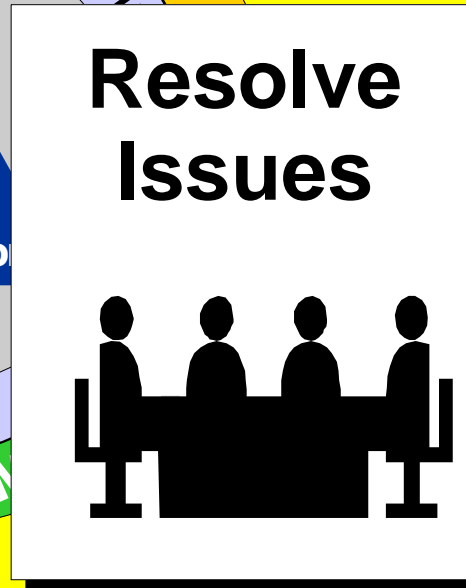
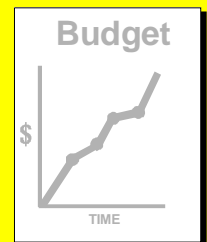
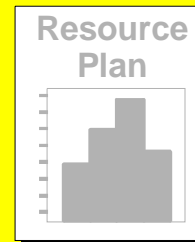
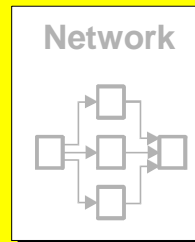
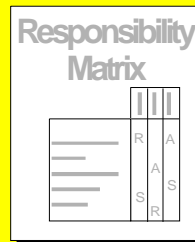
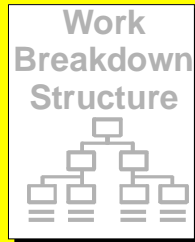
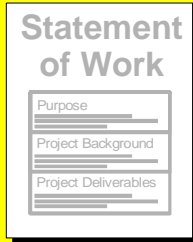

Issue Resolution

- ✱ Disagreements that should be ...
 - ✱ Documented
 - ✱ Assigned
 - ✱ Scheduled
 - ✱ Tracked
 - ✱ Escalated
 - ✱ Resolved



Break Timer

Roadmap to Project Management Success

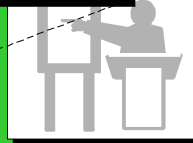
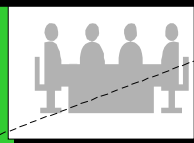
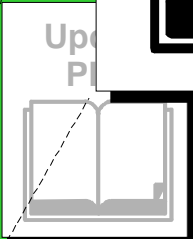
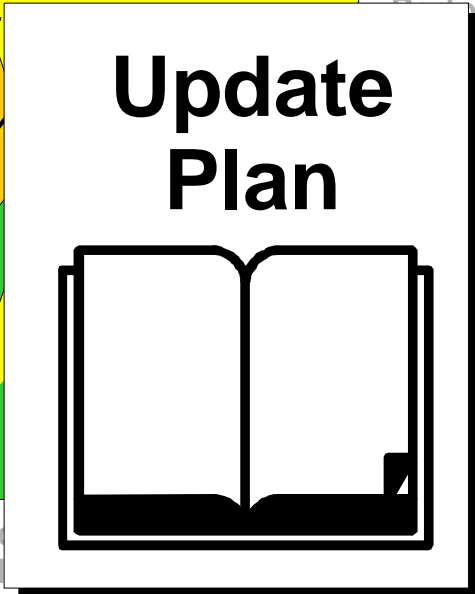
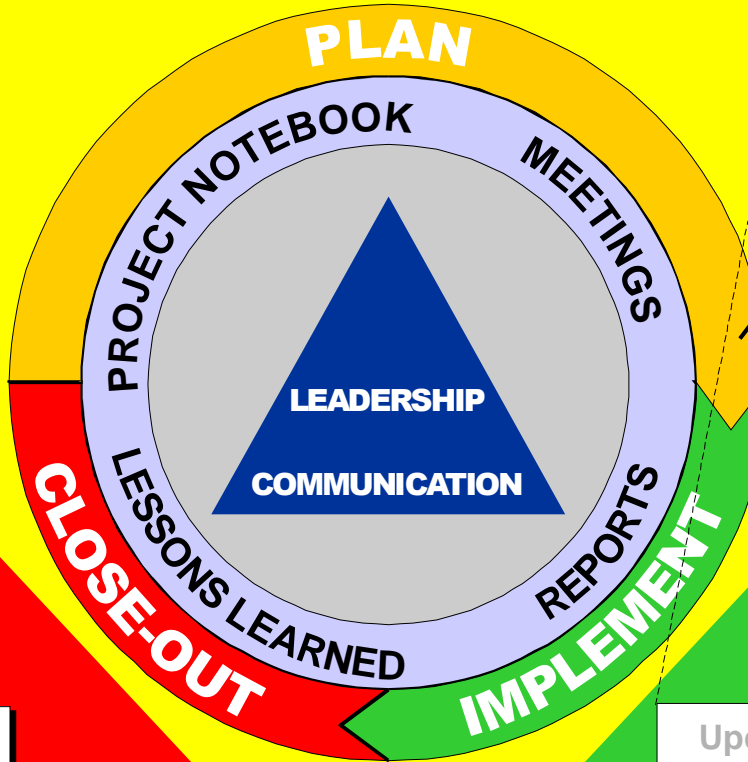
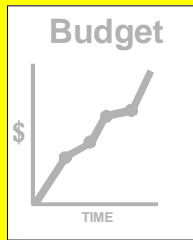
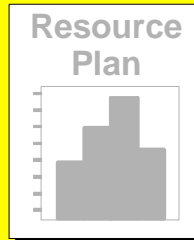
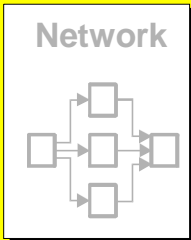
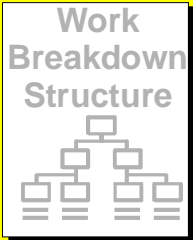
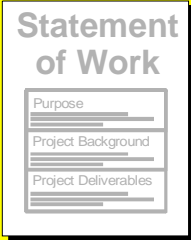

Plan Updates

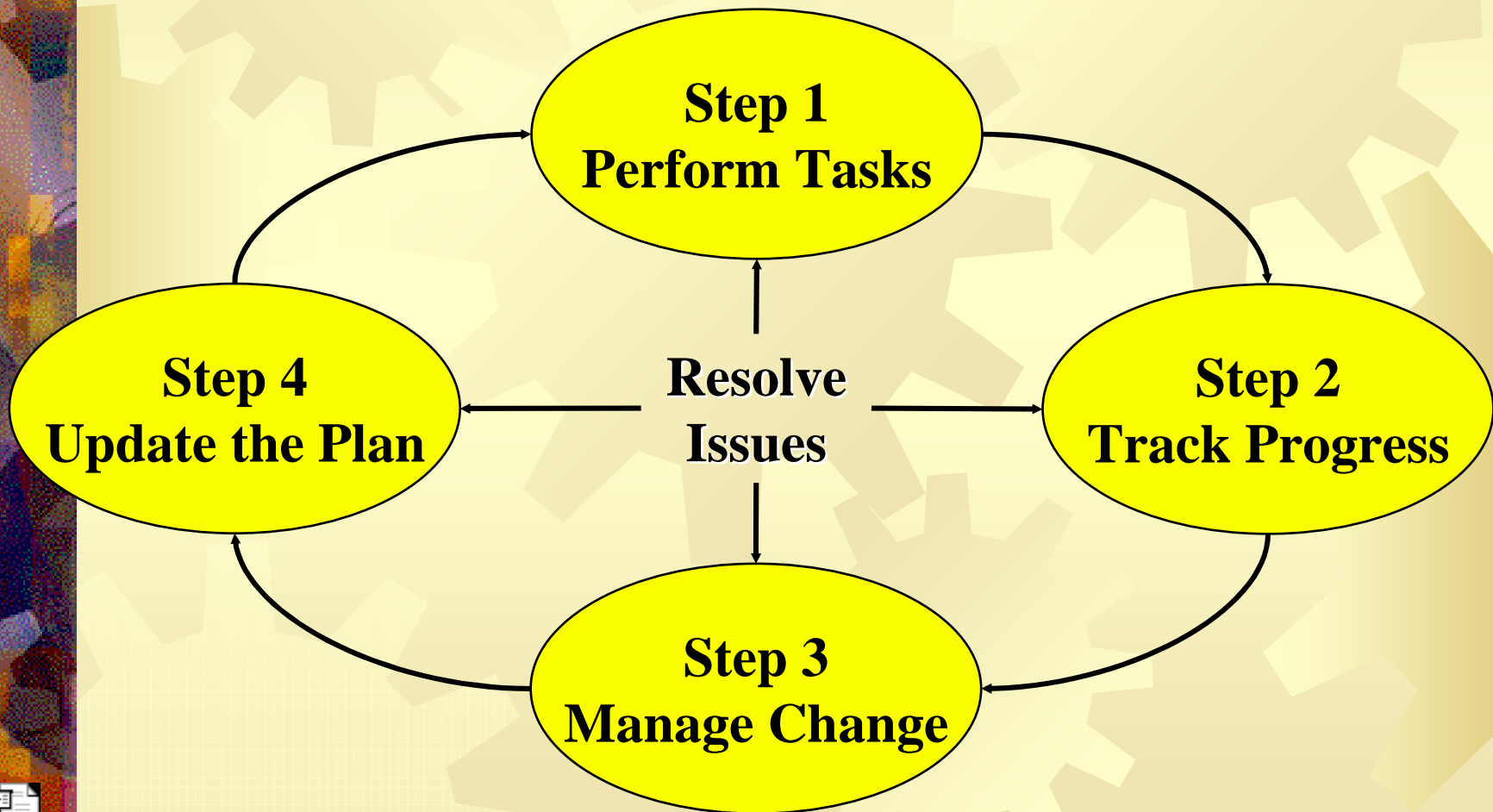

Break Timer

Closeout

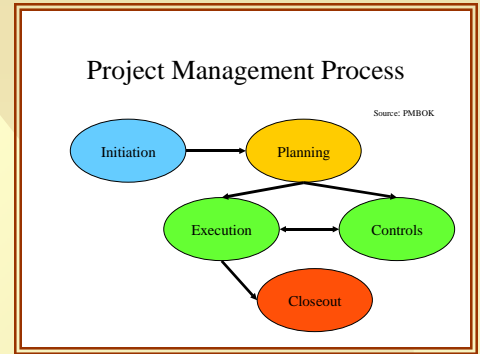

Break Timer



Roadmap to Project Management Success

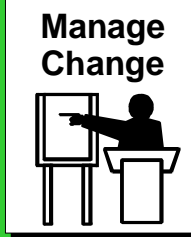
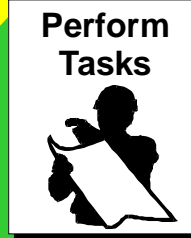
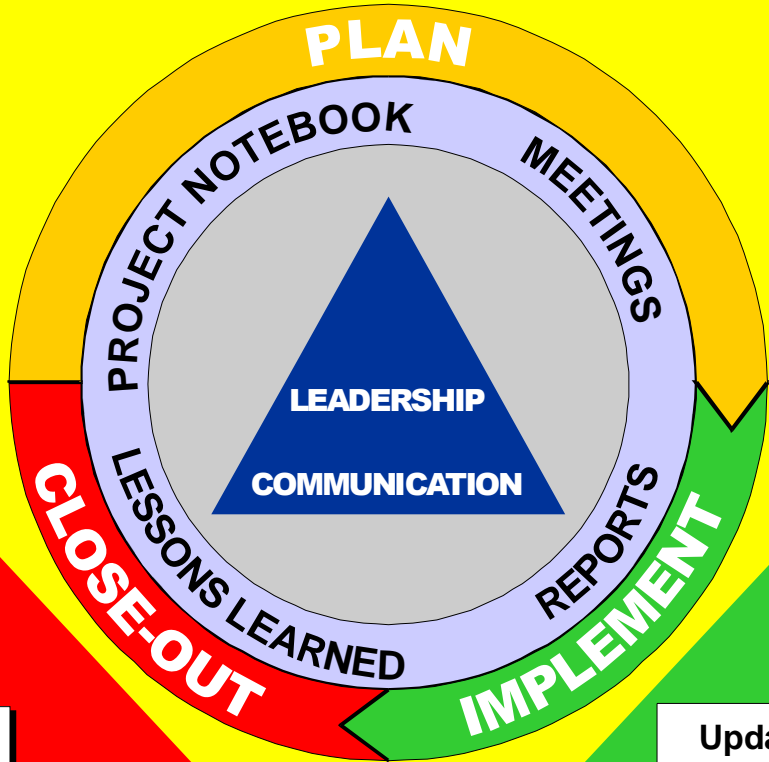
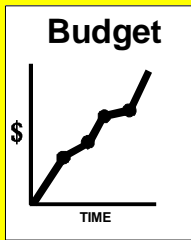
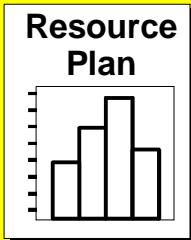
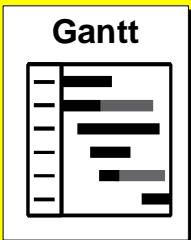
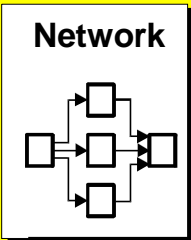
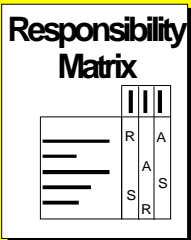
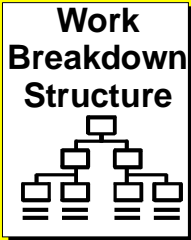
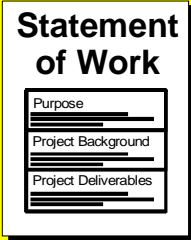

Project Manager's Role During Project Close-Out

- ✿ Ensure that all project deliverables have been completed and formally accepted by the customer.
- ✿ Determine if the measurable success indicators were achieved.
- ✿ Conduct project close-out meetings, both internal and external.
- ✿ Write the final project report.
- ✿ Document and share lessons learned.



Break Timer



Roadmap to Project Management Success

Form Project Team



Statement of Work

Purpose
Project Background
Project Deliverables

Work Breakdown Structure



Responsibility Matrix

	R	A
	S	S

Network

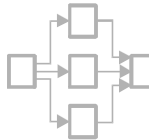

Gantt



Resource Plan

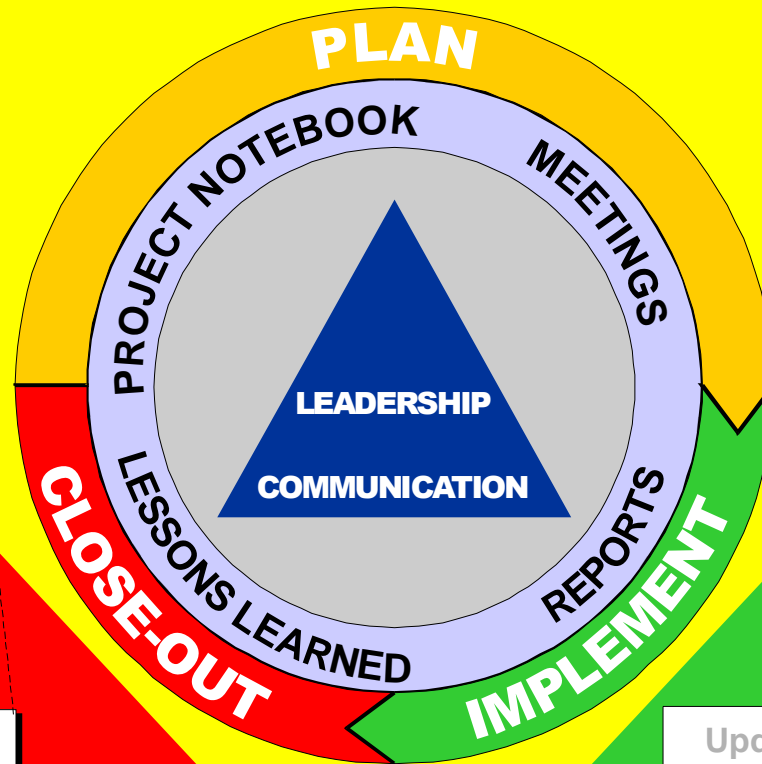

Budget

Evaluate Success



Perform Tasks



Track Progress



Update Plan



Resolve Issues



Manage Change



Lessons Learned



Evaluate Success



Evaluating Project Success

- ✿ Project purpose
- ✿ Deliverables
- ✿ Measurable success indicators
 - ✿ Quality
 - ✿ Schedule
 - ✿ Cost



Break Timer

Roadmap to Project Management Success

Form Project Team

Statement of Work

Work Breakdown Structure

Responsibility Matrix

Network

Gantt

Resource Plan

Budget

Conduct Close-Out Meeting

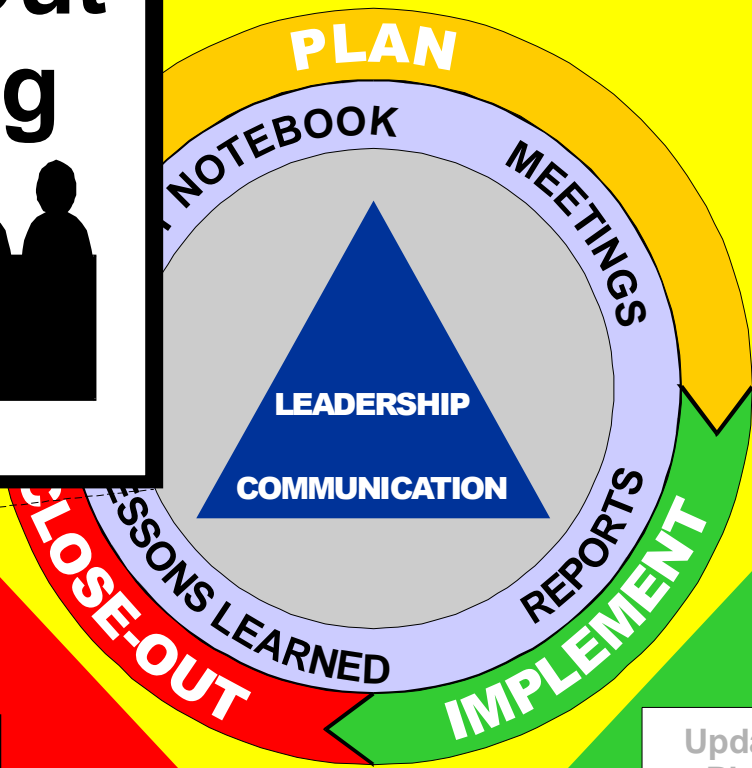

Conduct Close-Out Meeting

Perform Tasks

Track Progress

Share Lessons Learned

Evaluate Success

Update Plan

Resolve Issues

Manage Change

Informal Project Team Close-Out Meeting

- ★ Brainstorm to identify what went right with the project.
- ★ Brainstorm to identify what went wrong with the project.
- ★ List ideas for improvements.
- ★ List ideas for ensuring that what went right happens again.
- ★ Recognize the accomplishments of individuals.



Break Timer

Close-Out Meeting Agenda

- ✿ Review project statement of work.
- ✿ Review actual deliverables and show how project met its measurable success indicators.
- ✿ Summarize what was done well.
- ✿ Identify areas for improvement.
- ✿ Request recommendations for improvement.
- ✿ Determine if any additional tasks are required to complete the project.



Break Timer



Close-Out Meeting Agenda

(continued)

- ★ List additional tasks, responsible persons, and due date.
- ★ Document lessons learned for the project notebook.
- ★ Discuss the project notebook availability to appropriate personnel for future projects.
- ★ Evaluate subcontractor performance.



Break Timer



Roadmap to Project Management Success

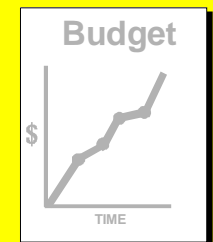
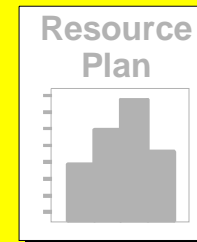
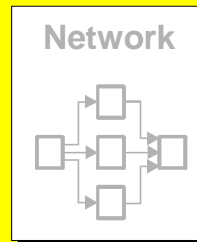
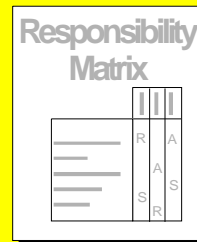
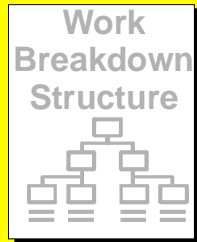
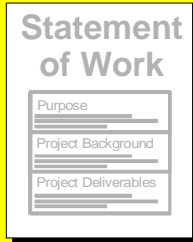

Share Lessons Learned

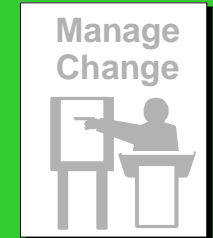
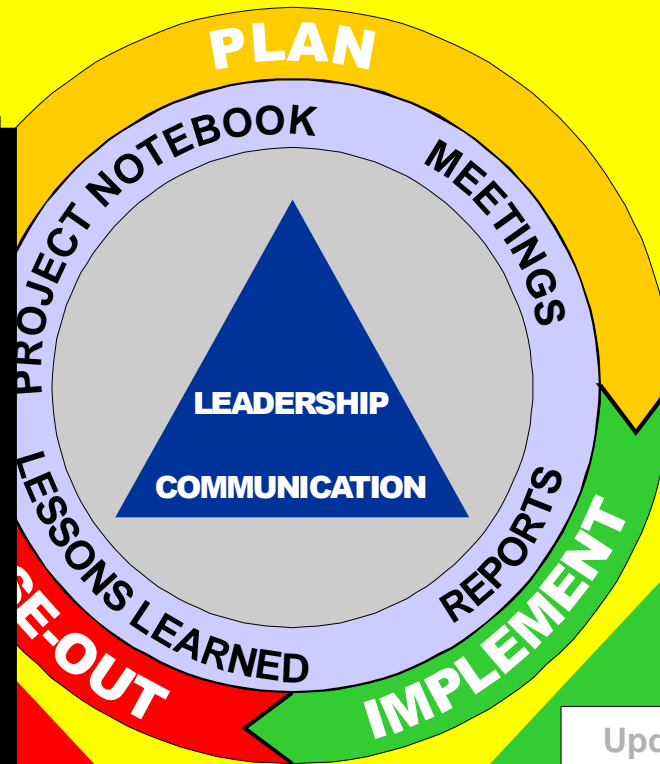
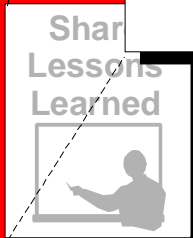
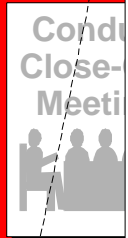

Sharing Lessons Learned

- Lessons Learned Database
 - Categorized electronic project information database
- Continuous Improvement Recommendations
 - Project Management Process
 - Forms
 - Standards



Break Timer



Roadmap to Project Management Success

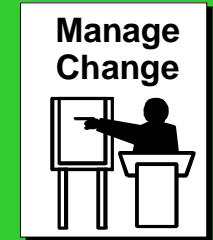
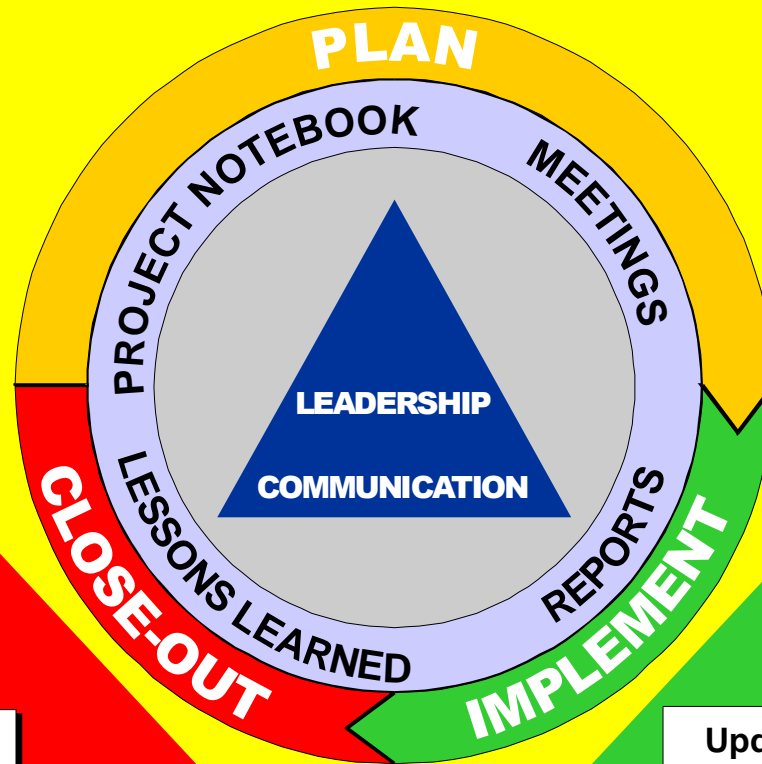
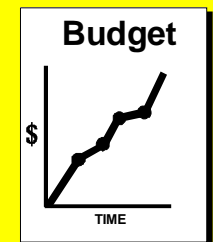
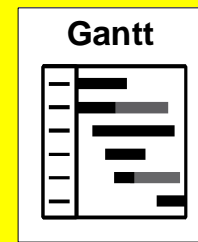
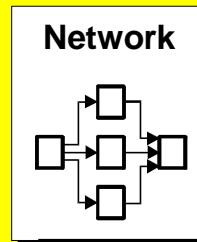
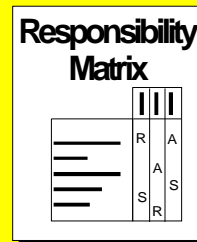
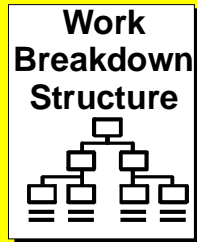
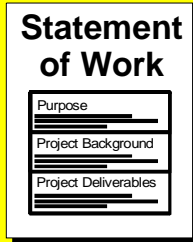

Thank You!!!!



Break Timer

